

Grease and Oil Wastes – Problems and Solutions

A grease trap is a device used for removing oil and grease from wastewaters. Grease traps perform this function very well, provided they are constructed and maintained properly.

Grease and oil that is allowed to enter the sewer system causes problems by separating from the wastewater and accumulating on the inside of sewer pipes. Over time, these deposits get larger as more grease and other solid material builds up. Grease deposits reduce the capacity of sewer pipes and cause sewage overflows, offensive odour and an unhealthy environment. The cleaning of grease deposits from sewers is difficult and can be dangerous and is carried out at considerable cost.

All restaurants and food processing factories are required to install grease traps so that greasy materials will be separated from wastewaters before passing to communal sewers. Restaurants and the food processing industry are the main sources of greasy waste and therefore it is very important that the grease traps used at these establishments are effective in removing grease from wastewater before it passes to the sewer system.

In many areas of Hong Kong, there are limits set by the Water Pollution Control Ordinance on the amount of grease and oil that can be allowed to pass to sewer. Grease traps are therefore very important as they assist you in conforming to these limits.

It is **YOUR RESPONSIBILITY** as a discharger of greasy wastes to ensure that:

- Grease traps are properly designed and constructed so as to effectively remove greasy materials from your kitchen wastewater before discharge to the sewer system.
- Your grease trap is properly maintained so that it can continue to function as an effective grease removal device and so that kitchen hygiene is preserved.
- Material removed from a grease trap is handled and disposed of properly in order to maintain kitchen hygiene and protect Hong Kong's environment.

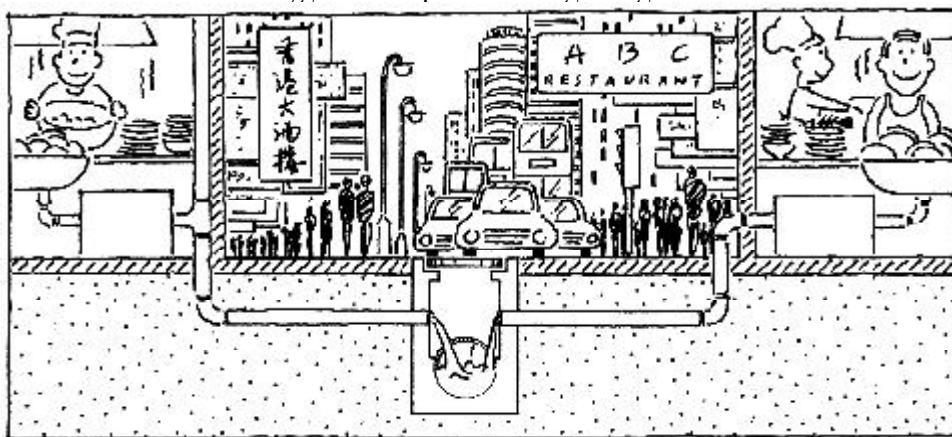

The Grease Trap

A grease trap is most commonly a two-chambered tank positioned along the wastewater drain pipe. Illustrations are provided on the centre pages of this booklet for reference. Wastewater slows down as it moves through the compartments of the trap, allowing time for less dense material to separate and rise to the liquid surface. Liquid and solid grease as well as light waste particles will be held in the trap while the wastewater below passes out.

The minimum requirements for grease trap design are:

- 1) Provide sufficient capacity to slow down the passing wastewater, giving greasy waste the opportunity to separate out.** A grease trap should be able to hold all the kitchen wastewater entering it during times of maximum water use for a period of 20 minutes. A grease trap connected to a single sink should not be smaller than 250 litre (55 gallons) capacity. A larger grease trap is used if more than one fixture is connected. Check the size of an existing grease trap or determine the approximate size of a new grease trap by following the instructions given on Page 3.
- 2) The length of the trap should be equal to between 1.3 and 2.0 times the total depth.** Note that usually the grease trap contents occupy $\frac{2}{3}$ of the total depth; the top $\frac{1}{3}$ of the trap is head space. Do not include wall and cover thickness in the length and depth measurements if the grease trap is built of concrete.
- 3) The surface area of the trap (the length times the width in square millimeters) should be equal to between 1000 and 2000 times the total depth measured in millimeters.** Again, do not include wall and cover thickness in measuring a concrete trap.
- 4) Prevent waste water entering the grease trap from mixing up the top greasy waste layer.** A baffle should be present at the trap inlet (see centre pages) to slow down the incoming wastewater and keep it separate from the top waste layer. The inlet pipe should end in a 90° downwards bend so that incoming wastewater enters the trap at least 100 mm below the water surface. The inlet pipe SHOULD NOT terminate above the liquid surface such that wastewater drops into the trap.
- 5) Allow access to the trap for maintenance so that all covers can be lifted and accumulated material removed from both the top and bottom of the trap.** Except for very large grease traps, the total depth of liquid should never exceed 1200 mm. A sampling hole with appropriate cover must also be provided if the opening for maintenance access does not also give access to the grease trap outlet.
- 6) Provide necessary safety features.** All grease traps must be vented. Under-floor grease traps and grease traps with over 1000 litre capacity must be provided with a prominent sign to show location, to indicate both total and liquid depth, and the maximum allowable thickness of the greasy waste layer (30%). Warning signs and safety barriers are to be deployed whenever these traps are opened.

ASSESSING EXISTING GREASE TRAP CAPACITY: To estimate the minimum grease trap capacity required, you need to know your typical water consumption over the supply billing period (in cubic metres; shown in the second column from the right on your water bill) and both the total number of days and hours per day that the establishment was open over the billing period.

Table 1 on Page 4 gives the grease trap capacity (the volume of material that can be held, Column C) required for a selection of hourly water consumption rates (Column A). To calculate your hourly water consumption rate in litres:

$$A = \frac{\text{Consumption from water bill, cubic metres}}{\text{number of working days over the billing period}} \div \frac{\text{working hours}}{\text{per day}} \times 1000$$

Example:

A restaurant open 6 days per week, 14 hours per day has a typical water bill showing consumption of 985 cubic metres over a 120 day billing period. The restaurant was open 104 days during this billing period.

Therefore, $A = 985 \div 104 \div 14 \times 1000 = 677$ litres/hour. From Table 1, the grease trap capacity required is around 970 litres.

The capacity of an existing grease trap in litres can be calculated from measurements of length, width and depth (in millimeters) and allowing for 2/3 of total trap depth to be occupied by contents.

$$\text{Capacity} = \text{Length} \times \text{Width} \times \text{Total Depth} \times 2 \div 3,000,000$$

ESTIMATING CAPACITY REQUIREMENTS FOR NEW ESTABLISHMENTS:

In this case, future water consumption can be estimated from the kitchen floor area that will be provided in the new restaurant. Column C of Table 1 below shows grease trap capacity requirements for different kitchen floor areas (Column B).

Example:

A new restaurant is planned with 30 square meters of kitchen floor area. (1 square meter = 10.8 square feet). From Table 1, the grease trap capacity required is just under 1,220 litres; approximately 1180 litres.

Note that these methods of estimating grease trap capacity requirements are included here only to give an indication of the minimum grease trap size that should be provided.

If an existing grease trap is smaller than the minimum requirement, it needs to be replaced. If you use more than 1000 litres of water per hour on average, you are advised to seek expert advice (from an Authorised Person, for example) regarding the installation of a single large grease trap or numerous small grease traps to meet your needs.

Food processing factories may require additional capacity or more advanced equipment for grease and oil removal and are recommended to seek expert advice in any case.

Table 1
Grease Trap Capacity Requirements

A	B	C	D		
AVERAGE HOURLY WATER USE (litres)	KITCHEN FLOOR AREA (square metres)	MINIMUM GREASE TRAP CAPACITY (litres)	EXAMPLE INTERNAL DIMENSIONS (millimeters)		
			LENGTH	WIDTH	TOTAL DEPTH
0 - 125		250	1200	525	600
250	8	490	1450	700	725
500	16	790	1700	825	850
750	24	1,050	1800	875	1000
1,000	32	1,220	1950	950	1000

Column D of Table 1 gives examples of grease trap dimensions that will provide both the required capacity and the length, width and depth relationships set out on Page 2.

Note that the dimensions shown in Table 1 are intended to give you a feel for the size of grease trap required. There are many combinations of length, width and depth that will meet the dimensional criteria for a given grease trap capacity. Remember that the liquid depth must be no greater than 1200 mm (and the total depth no greater than 1800 mm) for grease traps in the size range considered here.

Note that the length and width dimensions given in Table 1 DO NOT include wall and cover thickness for concrete grease traps (typically 150 mm). For steel traps, wall thicknesses can be ignored.

Ensure that any new grease trap installed at your restaurant or factory provides ALL of the necessary features listed on these pages. Check existing grease traps for all items in this list. If the features described on the preceding pages are not provided, you should seriously consider modifying or replacing the grease traps currently in use. Note that exceptionally greasy waste or unusually high wastewater flows may require additional capacity or features, as may food processing factories.

Seek expert advice regarding actual installation or replacement of grease traps whenever you are in doubt.

Grease Trap Maintenance

Greasy waste that accumulates in the grease trap must be removed regularly. The frequency of cleaning will vary depending on the type of food served and how active your business is. Regular cleaning keeps a grease trap working properly and will prevent clogging in kitchen drains and pipes.

Inspect the grease trap at least every three days and clean it promptly if the contents show the top 30% of liquid depth occupied by greasy waste. **Every grease trap is different and must be inspected regularly to determine if cleaning is required.**

If very little waste builds up in one week or if the surface layer is liquid oil only, the grease trap may not be functioning effectively. Check for proper design as outlined in this booklet and modify or replace the trap if necessary.

- Small grease traps may be cleaned by hand by scooping the top waste layer into a watertight bag or container. It is not necessary to empty the grease trap completely; remove only semi-solid layer of greasy waste on the top of the liquid surface.
- Clean the trap at a time when wastewater will not be passing through it. Take care not to leave lumps of grease in the trap as this may lead to clogging.
- Handle the greasy waste carefully to avoid contamination of food preparation or storage areas.
- Warning signs and safety barriers should be erected around under-floor and large grease traps during cleaning.
- Replace grease trap covers promptly and clean the surrounding area with a disinfectant.
- The grease trap waste container should be tightly sealed and disposed of with other kitchen refuse.
- **DO NOT** dispose of the grease trap waste to toilet, gulleys, surface channels or manholes.
- Record maintenance activities in a log book.

Clogging of the inlet or the pipes connecting the two chambers of the grease trap is not a common occurrence but if this happens, any obstruction can be pushed out from the open top of the pipe extending above the liquid surface (see centre pages).

Kitchen wastewater also carries pieces of solid waste that are heavier than water. In a grease trap, these solids fall to the bottom and form a layer of settled material. It is necessary to remove this bottom layer of settled waste occasionally, otherwise the grease trap capacity will be reduced. Carefully remove and dispose of this bottom material in the same manner as for the top layer of greasy waste.

Cleaning a grease trap is not a very pleasant job and staff members responsible for this task should be encouraged to carry it out promptly as required and thoroughly.

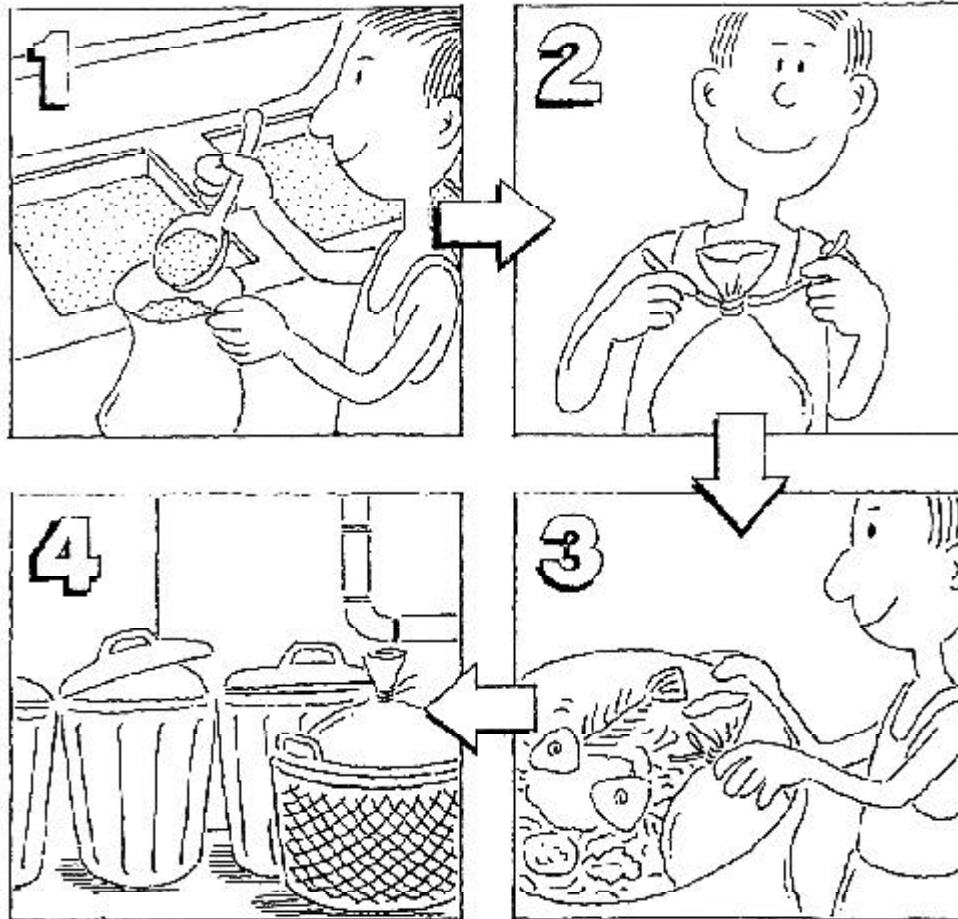

Grease traps larger than 1000 litres can be difficult to clean well by hand. Many restaurants hire external maintenance contractors to do the job and this practice is recommended to ensure complete and proper emptying.

Some things to check if you contract out grease trap maintenance:

- Employ registered grease trap waste collector to conduct the disposal work. The most updated list of the registered collectors can be obtained from the Environmental Protection Department.
- Be sure that the cleaning frequency is adequate. The trap should still be inspected by a member of your staff between maintenance visits; cleaning should take place when the greasy waste occupies no more than the top 30% of the trap capacity.
- Obtain monthly records that will enable you to prove grease trap maintenance at a later date, if required.

Waste Minimisation

There is a limit to the amount of waste material that grease traps can remove from wastewater. The addition of grease, oil and solid material to kitchen wastewater must be kept to a minimum (waste minimisation). Do this by disposing of these wastes as kitchen refuse rather than down the drain. In addition to reducing pollution in your wastewater, waste minimisation benefits you by reducing grease trap cleaning requirements and preventing drain and pipe clogging within your building.

Some suggestions for reducing waste quantities in kitchen wastewater follow. Consider adopting some or all of these as standard kitchen practice. Think about ways to minimise waste that will work at your restaurant. Waste minimisation will be successful if kitchen staff understand why it is necessary and are encouraged to participate; they may have some good ideas too.

- Scrape dirty serving dishes and cooking utensils into a garbage bin before washing.
- Dispose of floor sweepings and food scraps to a garbage bin before washing floors and food preparation surfaces.
- Use metal strainers or baskets in all drains. If this slows things down, keep two strainers on hand; quickly place one over the drain while the other is emptied.
- **NEVER** pour waste cooking oil down a drain or toilet. Waste oil and grease should be poured into a storage container which is discarded with other solid kitchen waste. Used paint cans, large food tins or other food supply containers can be used.
- Take care not to discharge excessive quantities of detergent and/or hot water as these are also considered to be pollutants.

It is damaging to both the public drainage system and the environment to prepare food or wash dishes in laneways behind restaurants.

It is illegal to dump waste water or waste food into gulleys and drains in the street. These drains are meant to carry rainwater. If clogged with grease and other waste the result is rats, cockroaches and overflows. During heavy rain storms, serious flooding with damage to life and property can occur if stormwater drains are clogged with waste.

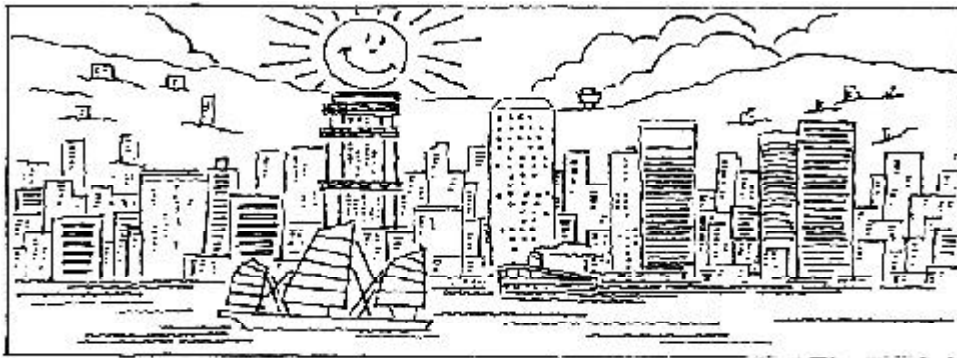

Environmental Protection Department Regional Offices

Regional Offices	Areas Covered	Address	Hotline & Fax	
Regional Office (East)	Sai Kung, Kwun Tong, Wong Tai Sin, Kowloon City & Yau Tsim Mong	5/F., Nan Fung Commercial Centre, 19 Lam Lok Street, Kowloon Bay, Kowloon.	Hotline	: 2755 5518
			Fax.	: 2756 8588
Regional Office (South)	Hong Kong Island & Islands	2/F., Chinachem Exchange Square, 1 Hoi Wan Street, Quarry Bay, Hong Kong.	Hotline	: 2516 1718
			Fax.	: 2960 1760
Regional Office (West)	Tuen Mun, Tsuen Wan, Kwai Tsing & Sham Shui Po	8/F., Tsuen Wan Government Offices, 38 Sai Lau Kok Road, Tsuen Wan, New Territories.	Hotline	: 2417 6116
			Fax.	: 2411 3073
Regional Office (North)	Yuen Long, Shatin, Tai Po & North	10/F., Shatin Government Offices, No.1 Sheung Wo Che Road, Shatin, New Territories.	Hotline	: 2158 5757
			Fax.	: 2685 1133

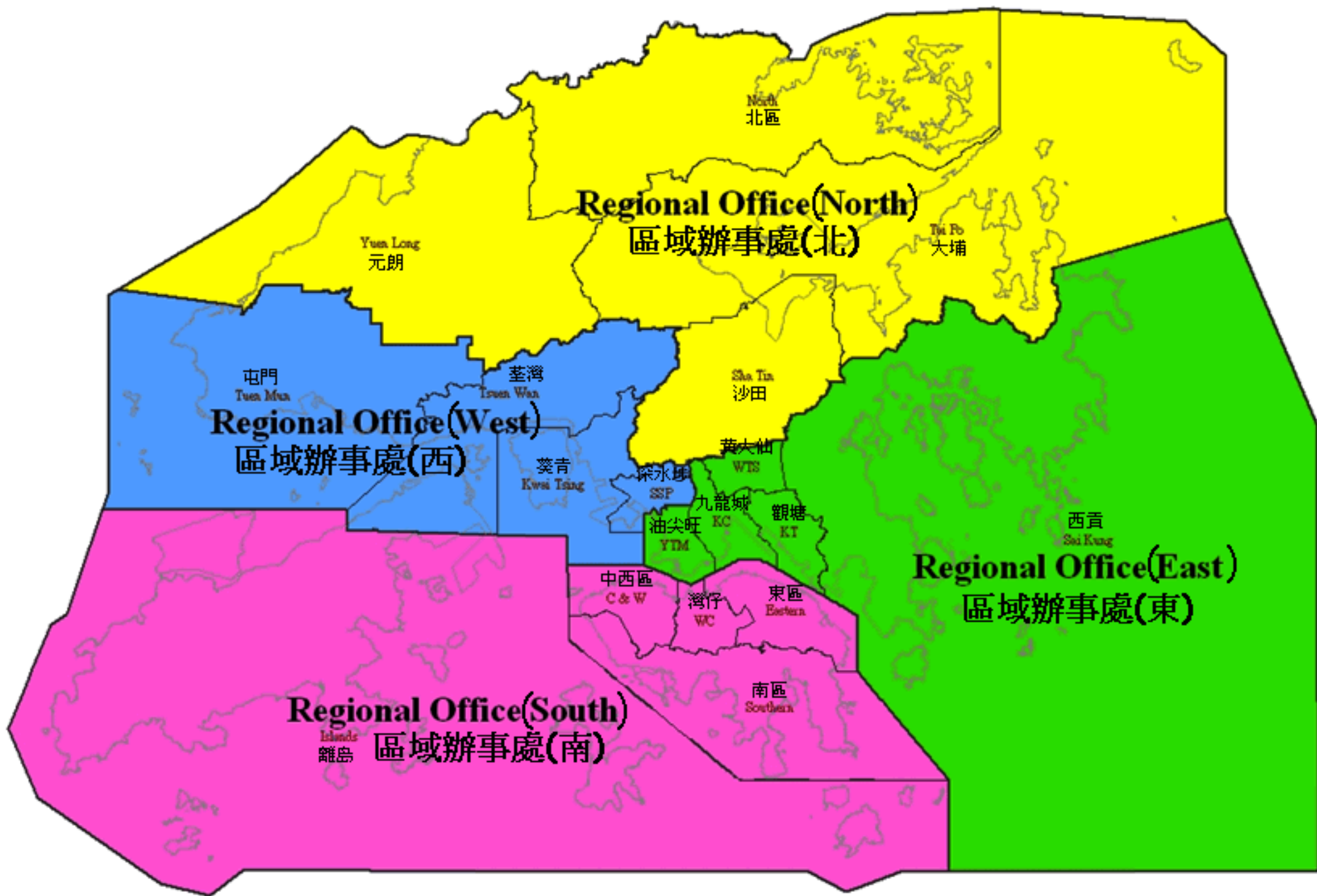

North
北區

Regional Office(North)
區域辦事處(北)

Tai Po
大埔

Yuen Long
元朗

Tuen Mun
屯門

Regional Office(West)
區域辦事處(西)

Sha Tin
沙田

Luen Wan
荃灣

WTS
黃大仙

Kwai Tsing
葵青

SSP
深水埗

YTM
油尖旺

KC
九龍城

KT
觀塘

Sai Kung
西貢

Regional Office(East)
區域辦事處(東)

C & W
中西區

WC
灣仔

Eastern
東區

Regional Office(South)
區域辦事處(南)

Islands
離島

Southern
南區

隔油池的兩個側視圖，圖中顯示了頂部的廢油脂層和底部的沉積廢物層

TWO VIEWS OF A GREASE TRAP WHICH SHOW THE TOP LAYER OF GREASY WASTE AND THE BOTTOM LAYER OF SETTLED SOLIDS

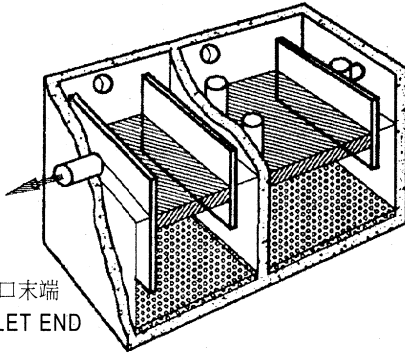

出水口末端
OUTLET END

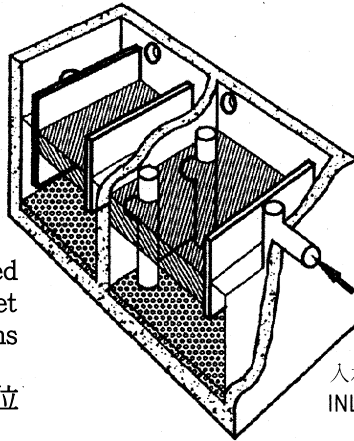

入水口末端
INLET END

Sampling point should be provided immediately after the grease trap outlet or at other convenient locations downstream of the grease trap outlet
應於於隔油池出水口後或其下游的便利位置設置抽樣點

隔油池示意圖之圖例

KEY TO GREASE TRAP ILLUSTRATION ON FACING PAGE

All dimensions in millimeters

W = width $W < L_1 < L_2 < 2000$
 L_T = total length = $L_1 + L_2$
 L_1 = length of first chamber
 L_2 = length of second chamber
 H_T = total depth = $H_L + H_s \leq 1800$
 H_L = liquid depth ≤ 1200
 H_s = head space = $1/3 H_T$
 CAPACITY = $\frac{W \times L_T \times H_L}{1,000,000} \geq 250$ Litres

$$1.3 \leq L_T + H_T \leq 2.0$$

$$1000 \leq W \times L_T + H_T \leq 2000$$

d = pipe diameter ≥ 100

All baffles placed distance $d+50$ from trap wall

All baffles extend $1.5d$ above liquid surface

A = inlet baffle depth
 = $3d$ OR $2/3 H_L$, whichever is greater
 but ≤ 500

Diameter of vent holes and pipes ≥ 80

尺寸均以毫米為單位

W = 寬度 $W < L_1 < L_2 < 2000$
 L_T = 總長度 = $L_1 + L_2$
 L_1 = 第一隔間長度
 L_2 = 第二隔間長度
 H_T = 總深度 = $H_L + H_s \leq 1800$
 H_L = 液體深度 ≤ 1200
 H_s = 頂高 = $1/3 H_T$
 容量 = $\frac{W \times L_T \times H_L}{1,000,000} \geq 250$ 升

$$1.3 \leq L_T + H_T \leq 2.0$$

$$1000 \leq W \times L_T + H_T \leq 2000$$

d = 管徑 ≥ 100

所有隔板應距池邊 $d+50$ (壹個管徑+50) 的距離

所有隔板應高於液面 $1.5d$ (壹個半管徑) 的距離

A = 入水口隔板的深度
 = $3d$ 或 $2/3 H_L$ 以較大者為準
 但 ≤ 500

通風口及管的直徑 ≥ 80

隔油池頂部外視圖 (尺寸均以毫米為單位)

EXTERNAL TOP VIEW OF GREASE TRAP (all dimensions in mm)

CLEAR OPENING FOR ACCESS

500X500mm MIN. WITH LIGHT WEIGHT COVER

出入口輕便活動蓋板

最小尺寸 500X500 毫米

SAMPLING POINT IMMEDIATELY AFTER THE GREASE TRAP OUTLET
抽樣點位於隔油池出水口後

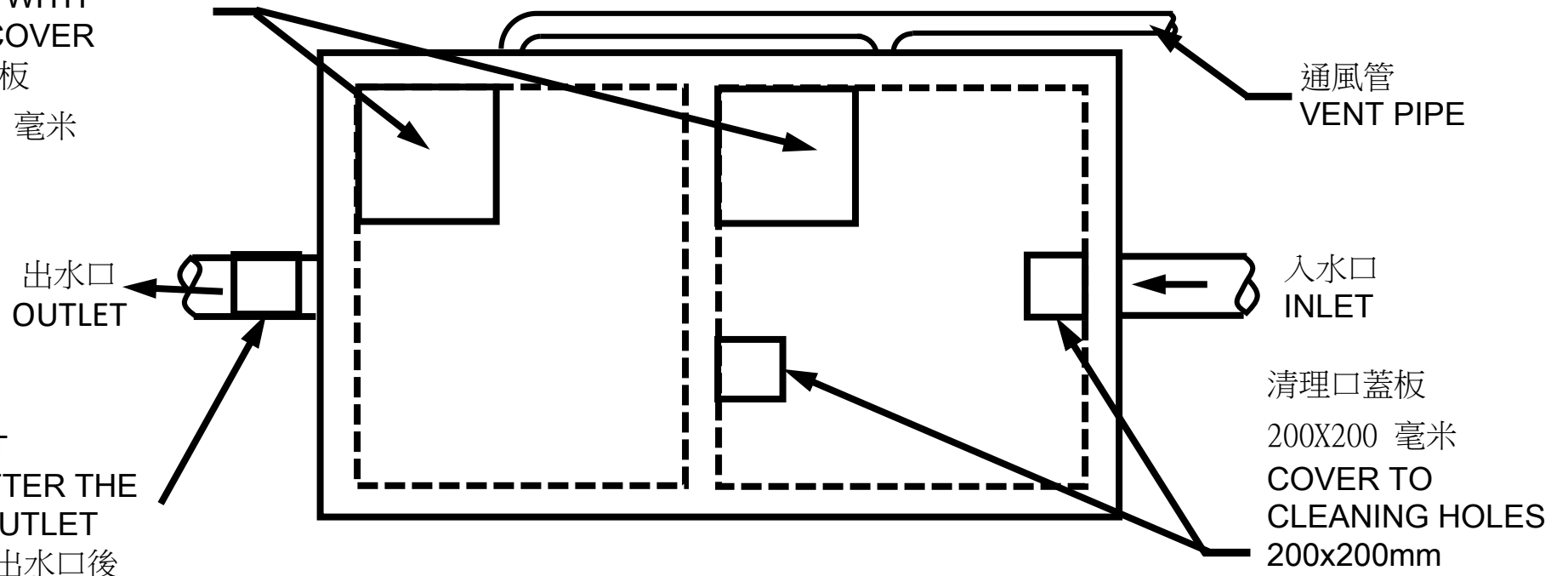

混凝土隔油池頂視圖 (無蓋) (尺寸均以毫米為單位)

TOP VIEW WITHOUT COVER, CONCRETE GREASE TRAP (all dimensions in mm)

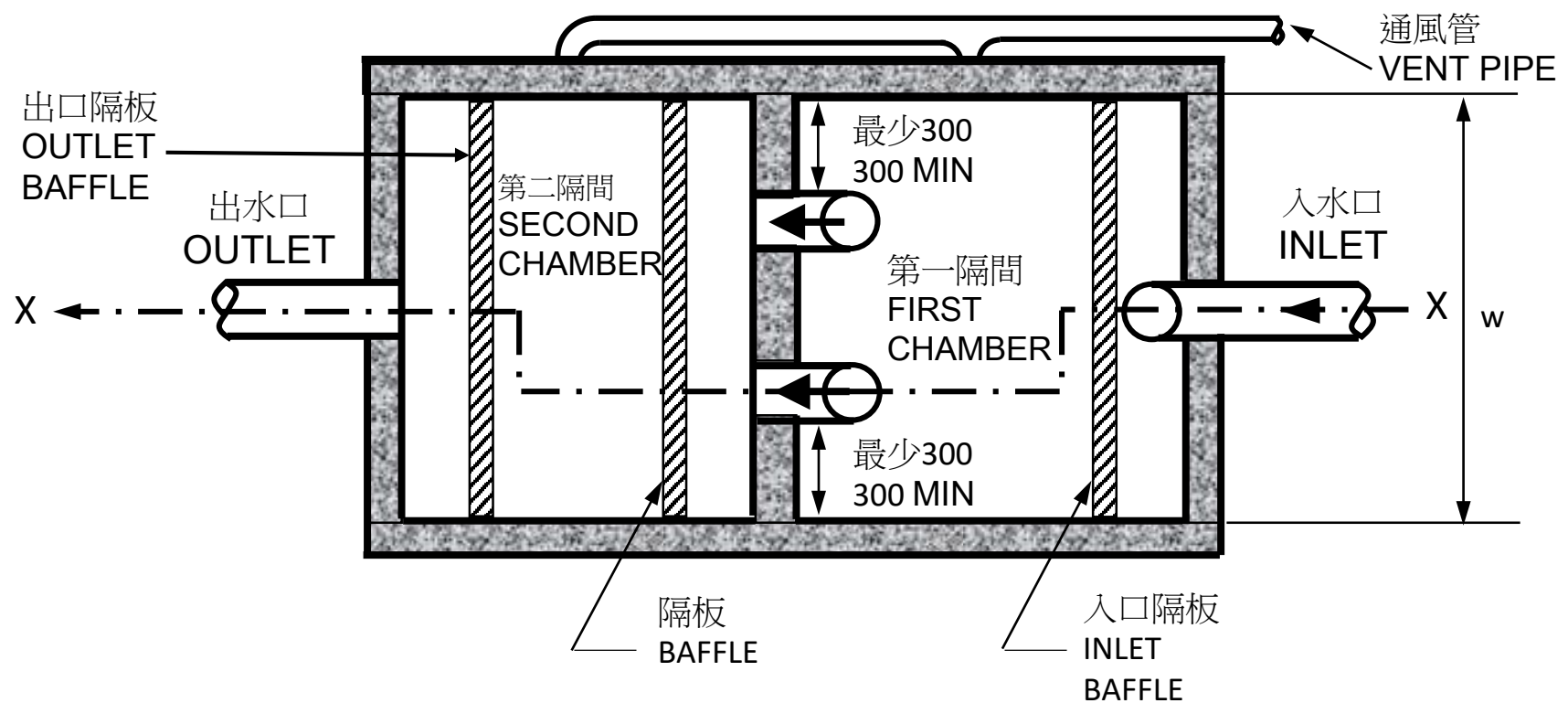

橫切面 X-X 側視圖(尺寸均以毫米為單位)

SIDE VIEW THROUGH SECTION X-X (all dimensions in mm)

