

FLOOR LEVEL

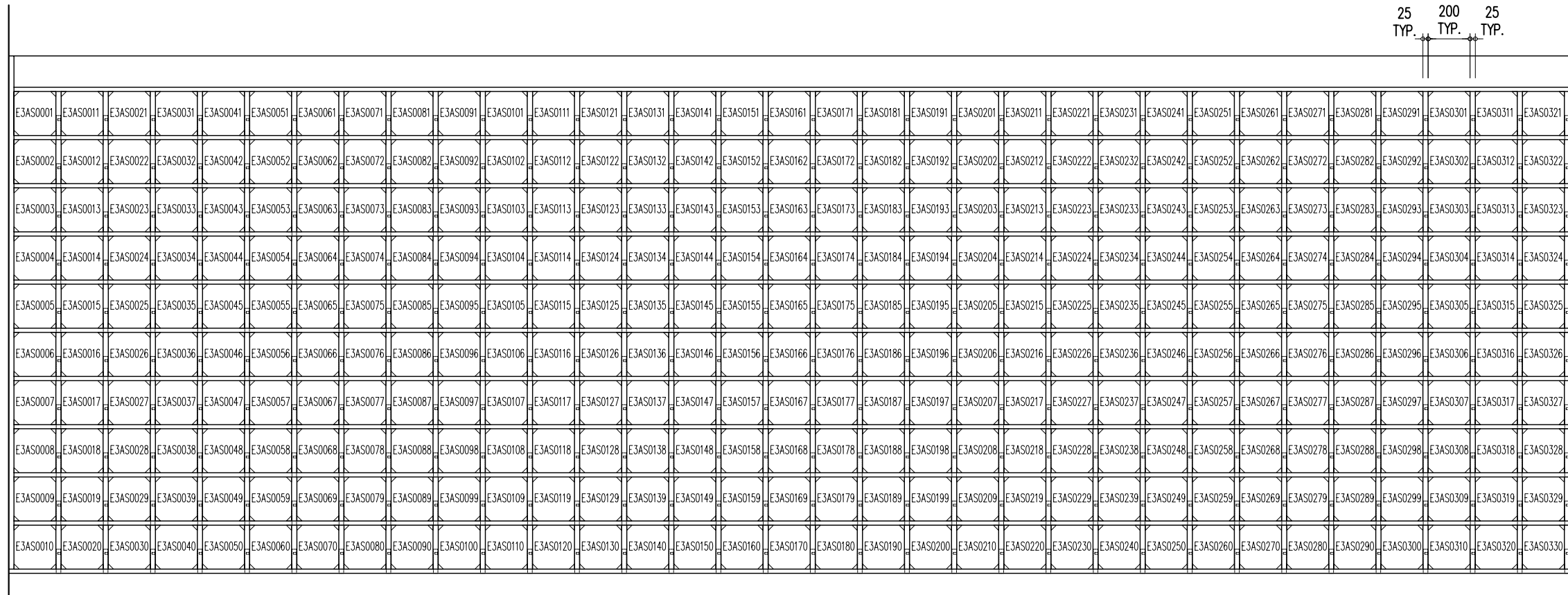

25 TYP. 200 TYP. 25 TYP.

20 TYP. 210 TYP. 20 TYP.

E3AS0001 ~ E3AS0330  
3/F ELEVATION A

25 TYP. 200 TYP. 25 TYP.

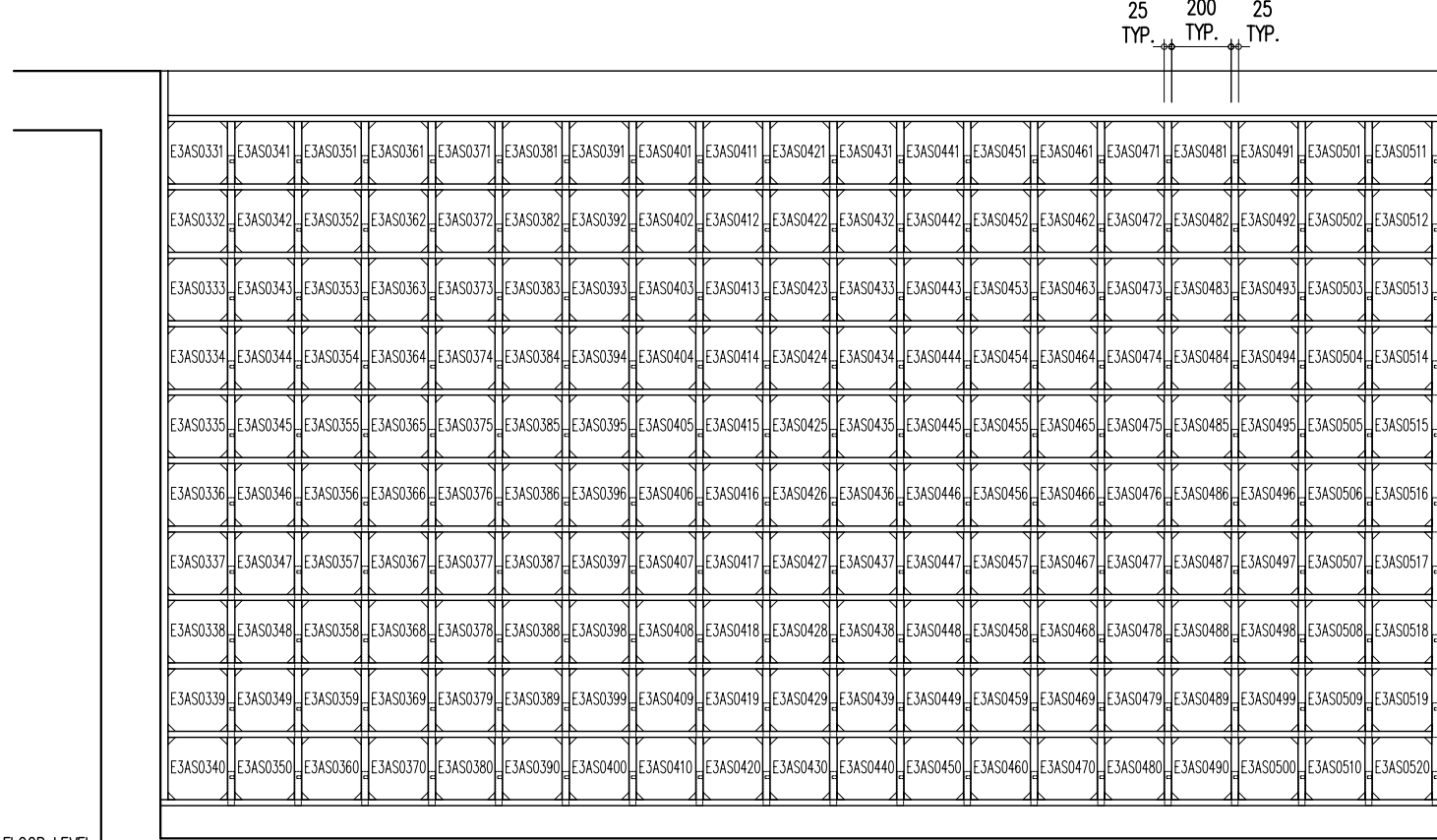

20 TYP. 210 TYP. 20 TYP.

FLOOR LEVEL

E3AS0331 ~ E3AS0520  
3/F ELEVATION B

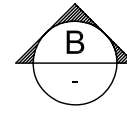
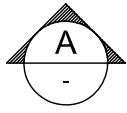
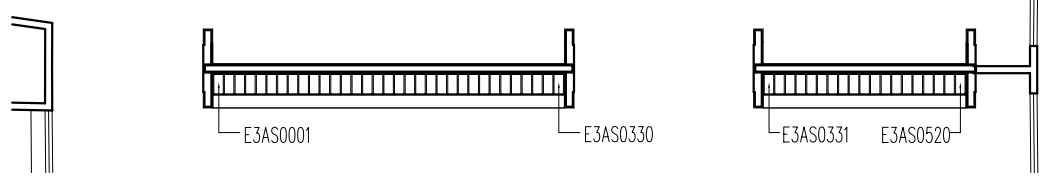

3/F FLOOR PLAN



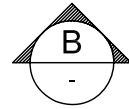
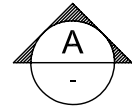
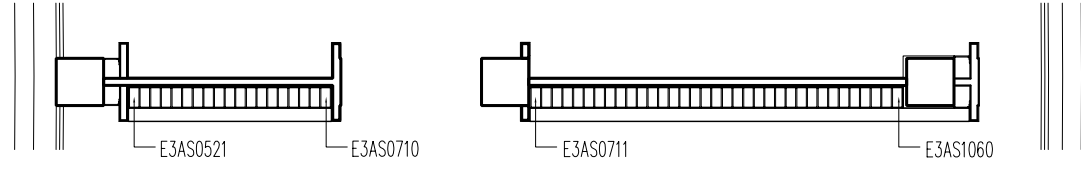

3/F FLOOR PLAN

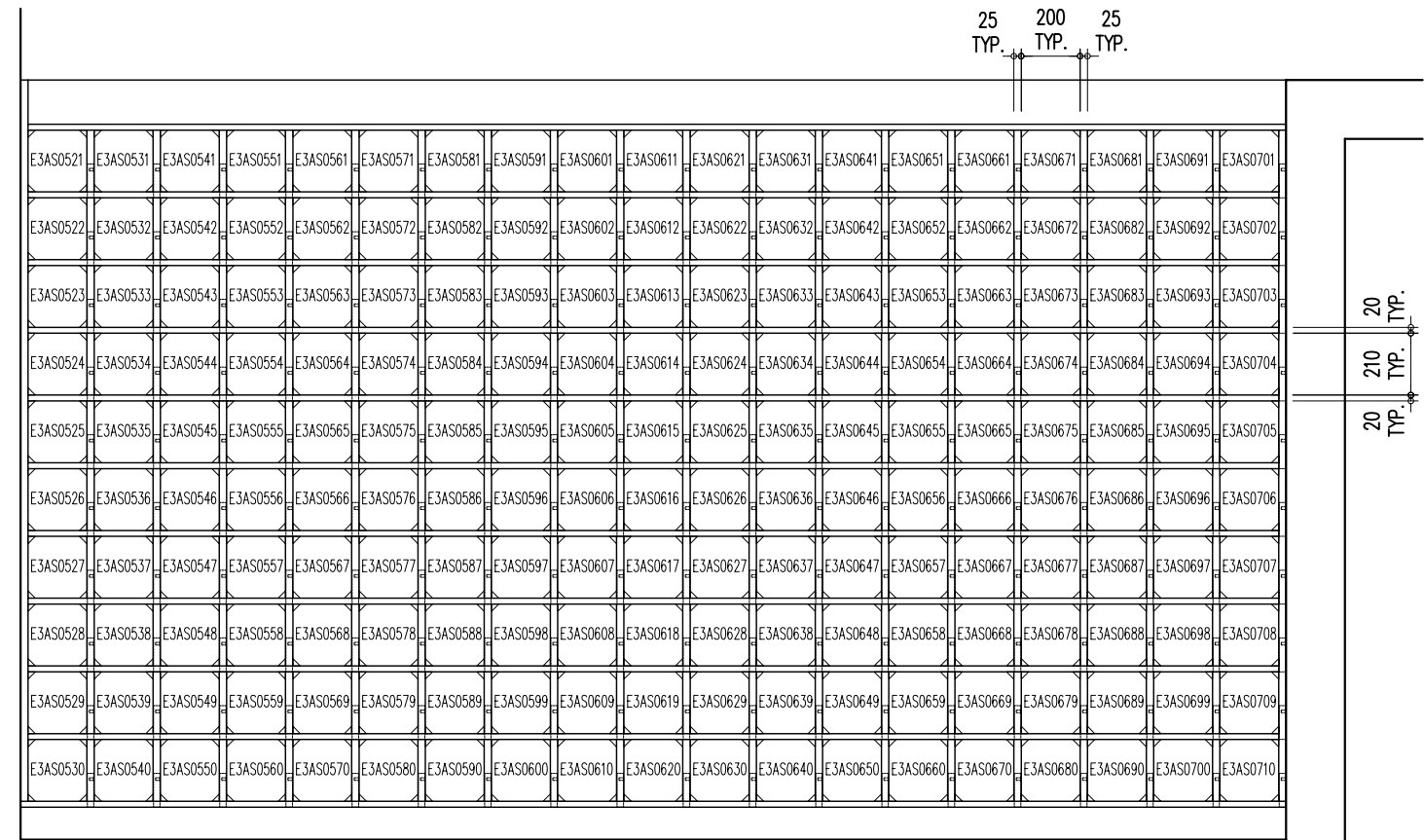

FLOOR LEVEL  
▽

E3AS0521 ~ E3AS0710  
3/F ELEVATION A

25 TYP. 200 TYP. 25 TYP.

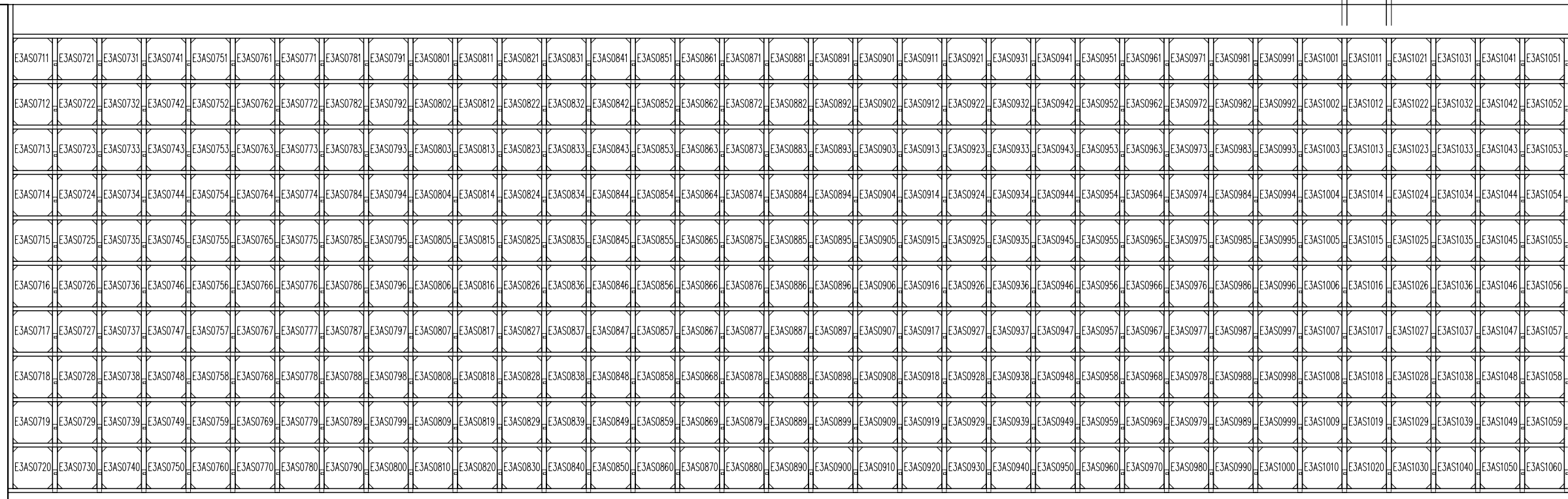

FLOOR LEVEL  
▽

E3AS0711 ~ E3AS1060  
3/F ELEVATION B

E3BS0001	E3BS0011	E3BS0021	E3BS0031	E3BS0041	E3BS0051	E3BS0061	E3BS0071	E3BS0081	E3BS0091	E3BS0101	E3BS0111	E3BS0121	E3BS0131	E3BS0141	E3BS0151	E3BS0161	E3BS0171	E3BS0181	E3BS0191	E3BS0201	E3BS0211	E3BS0221	E3BS0231	E3BS0241	E3BS0251	E3BS0261	E3BS0271	E3BS0281	E3BS0291	E3BS0301	E3BS0311	E3BS0321	E3BS0331	E3BS0341
E3BS0002	E3BS0012	E3BS0022	E3BS0032	E3BS0042	E3BS0052	E3BS0062	E3BS0072	E3BS0082	E3BS0092	E3BS0102	E3BS0112	E3BS0122	E3BS0132	E3BS0142	E3BS0152	E3BS0162	E3BS0172	E3BS0182	E3BS0192	E3BS0202	E3BS0212	E3BS0222	E3BS0232	E3BS0242	E3BS0252	E3BS0262	E3BS0272	E3BS0282	E3BS0292	E3BS0302	E3BS0312	E3BS0322	E3BS0332	E3BS0342
E3BS0003	E3BS0013	E3BS0023	E3BS0033	E3BS0043	E3BS0053	E3BS0063	E3BS0073	E3BS0083	E3BS0093	E3BS0103	E3BS0113	E3BS0123	E3BS0133	E3BS0143	E3BS0153	E3BS0163	E3BS0173	E3BS0183	E3BS0193	E3BS0203	E3BS0213	E3BS0223	E3BS0233	E3BS0243	E3BS0253	E3BS0263	E3BS0273	E3BS0283	E3BS0293	E3BS0303	E3BS0313	E3BS0323	E3BS0333	E3BS0343
E3BS0004	E3BS0014	E3BS0024	E3BS0034	E3BS0044	E3BS0054	E3BS0064	E3BS0074	E3BS0084	E3BS0094	E3BS0104	E3BS0114	E3BS0124	E3BS0134	E3BS0144	E3BS0154	E3BS0164	E3BS0174	E3BS0184	E3BS0194	E3BS0204	E3BS0214	E3BS0224	E3BS0234	E3BS0244	E3BS0254	E3BS0264	E3BS0274	E3BS0284	E3BS0294	E3BS0304	E3BS0314	E3BS0324	E3BS0334	E3BS0344
E3BS0005	E3BS0015	E3BS0025	E3BS0035	E3BS0045	E3BS0055	E3BS0065	E3BS0075	E3BS0085	E3BS0095	E3BS0105	E3BS0115	E3BS0125	E3BS0135	E3BS0145	E3BS0155	E3BS0165	E3BS0175	E3BS0185	E3BS0195	E3BS0205	E3BS0215	E3BS0225	E3BS0235	E3BS0245	E3BS0255	E3BS0265	E3BS0275	E3BS0285	E3BS0295	E3BS0305	E3BS0315	E3BS0325	E3BS0335	E3BS0345
E3BS0006	E3BS0016	E3BS0026	E3BS0036	E3BS0046	E3BS0056	E3BS0066	E3BS0076	E3BS0086	E3BS0096	E3BS0106	E3BS0116	E3BS0126	E3BS0136	E3BS0146	E3BS0156	E3BS0166	E3BS0176	E3BS0186	E3BS0196	E3BS0206	E3BS0216	E3BS0226	E3BS0236	E3BS0246	E3BS0256	E3BS0266	E3BS0276	E3BS0286	E3BS0296	E3BS0306	E3BS0316	E3BS0326	E3BS0336	E3BS0346
E3BS0007	E3BS0017	E3BS0027	E3BS0037	E3BS0047	E3BS0057	E3BS0067	E3BS0077	E3BS0087	E3BS0097	E3BS0107	E3BS0117	E3BS0127	E3BS0137	E3BS0147	E3BS0157	E3BS0167	E3BS0177	E3BS0187	E3BS0197	E3BS0207	E3BS0217	E3BS0227	E3BS0237	E3BS0247	E3BS0257	E3BS0267	E3BS0277	E3BS0287	E3BS0297	E3BS0307	E3BS0317	E3BS0327	E3BS0337	E3BS0347
E3BS0008	E3BS0018	E3BS0028	E3BS0038	E3BS0048	E3BS0058	E3BS0068	E3BS0078	E3BS0088	E3BS0098	E3BS0108	E3BS0118	E3BS0128	E3BS0138	E3BS0148	E3BS0158	E3BS0168	E3BS0178	E3BS0188	E3BS0198	E3BS0208	E3BS0218	E3BS0228	E3BS0238	E3BS0248	E3BS0258	E3BS0268	E3BS0278	E3BS0288	E3BS0298	E3BS0308	E3BS0318	E3BS0328	E3BS0338	E3BS0348
E3BS0009	E3BS0019	E3BS0029	E3BS0039	E3BS0049	E3BS0059	E3BS0069	E3BS0079	E3BS0089	E3BS0099	E3BS0109	E3BS0119	E3BS0129	E3BS0139	E3BS0149	E3BS0159	E3BS0169	E3BS0179	E3BS0189	E3BS0199	E3BS0209	E3BS0219	E3BS0229	E3BS0239	E3BS0249	E3BS0259	E3BS0269	E3BS0279	E3BS0289	E3BS0299	E3BS0309	E3BS0319	E3BS0329	E3BS0339	E3BS0349
E3BS0010	E3BS0020	E3BS0030	E3BS0040	E3BS0050	E3BS0060	E3BS0070	E3BS0080	E3BS0090	E3BS0100	E3BS0110	E3BS0120	E3BS0130	E3BS0140	E3BS0150	E3BS0160	E3BS0170	E3BS0180	E3BS0190	E3BS0200	E3BS0210	E3BS0220	E3BS0230	E3BS0240	E3BS0250	E3BS0260	E3BS0270	E3BS0280	E3BS0290	E3BS0300	E3BS0310	E3BS0320	E3BS0330	E3BS0340	E3BS0350

25 TYP. 200 TYP. 25 TYP.

20 TYP. 210 TYP. 20 TYP.

FLOOR LEVEL

E3BS0001 ~ E3BS0350  
3/F ELEVATION A

E3BS0351	E3BS0361	E3BS0371	E3BS0381	E3BS0391	E3BS0401	E3BS0411	E3BS0421	E3BS0431	E3BS0441	E3BS0451	E3BS0461	E3BS0471	E3BS0481	E3BS0491	E3BS0501	E3BS0511	E3BS0521	E3BS0531
E3BS0352	E3BS0362	E3BS0372	E3BS0382	E3BS0392	E3BS0402	E3BS0412	E3BS0422	E3BS0432	E3BS0442	E3BS0452	E3BS0462	E3BS0472	E3BS0482	E3BS0492	E3BS0502	E3BS0512	E3BS0522	E3BS0532
E3BS0353	E3BS0363	E3BS0373	E3BS0383	E3BS0393	E3BS0403	E3BS0413	E3BS0423	E3BS0433	E3BS0443	E3BS0453	E3BS0463	E3BS0473	E3BS0483	E3BS0493	E3BS0503	E3BS0513	E3BS0523	E3BS0533
E3BS0354	E3BS0364	E3BS0374	E3BS0384	E3BS0394	E3BS0404	E3BS0414	E3BS0424	E3BS0434	E3BS0444	E3BS0454	E3BS0464	E3BS0474	E3BS0484	E3BS0494	E3BS0504	E3BS0514	E3BS0524	E3BS0534
E3BS0355	E3BS0365	E3BS0375	E3BS0385	E3BS0395	E3BS0405	E3BS0415	E3BS0425	E3BS0435	E3BS0445	E3BS0455	E3BS0465	E3BS0475	E3BS0485	E3BS0495	E3BS0505	E3BS0515	E3BS0525	E3BS0535
E3BS0356	E3BS0366	E3BS0376	E3BS0386	E3BS0396	E3BS0406	E3BS0416	E3BS0426	E3BS0436	E3BS0446	E3BS0456	E3BS0466	E3BS0476	E3BS0486	E3BS0496	E3BS0506	E3BS0516	E3BS0526	E3BS0536
E3BS0357	E3BS0367	E3BS0377	E3BS0387	E3BS0397	E3BS0407	E3BS0417	E3BS0427	E3BS0437	E3BS0447	E3BS0457	E3BS0467	E3BS0477	E3BS0487	E3BS0497	E3BS0507	E3BS0517	E3BS0527	E3BS0537
E3BS0358	E3BS0368	E3BS0378	E3BS0388	E3BS0398	E3BS0408	E3BS0418	E3BS0428	E3BS0438	E3BS0448	E3BS0458	E3BS0468	E3BS0478	E3BS0488	E3BS0498	E3BS0508	E3BS0518	E3BS0528	E3BS0538
E3BS0359	E3BS0369	E3BS0379	E3BS0389	E3BS0399	E3BS0409	E3BS0419	E3BS0429	E3BS0439	E3BS0449	E3BS0459	E3BS0469	E3BS0479	E3BS0489	E3BS0499	E3BS0509	E3BS0519	E3BS0529	E3BS0539
E3BS0360	E3BS0370	E3BS0380	E3BS0390	E3BS0400	E3BS0410	E3BS0420	E3BS0430	E3BS0440	E3BS0450	E3BS0460	E3BS0470	E3BS0480	E3BS0490	E3BS0500	E3BS0510	E3BS0520	E3BS0530	E3BS0540

25 TYP. 200 TYP. 25 TYP.

20 TYP. 210 TYP. 20 TYP.

FLOOR LEVEL

E3BS0351 ~ E3BS0540  
3/F ELEVATION B

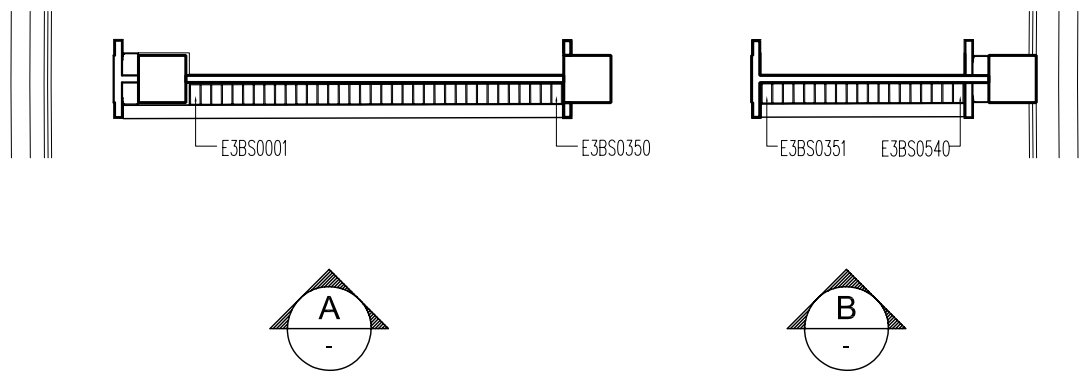

3/F FLOOR PLAN

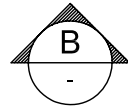
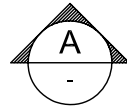
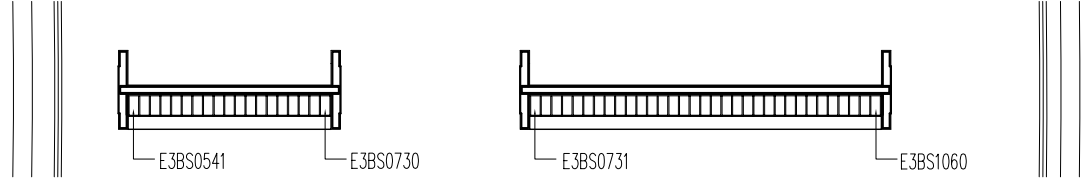

3/F FLOOR PLAN

FLOOR LEVEL

E3BS0541	E3BS0551	E3BS0561	E3BS0571	E3BS0581	E3BS0591	E3BS0601	E3BS0611	E3BS0621	E3BS0631	E3BS0641	E3BS0651	E3BS0661	E3BS0671	E3BS0681	E3BS0691	E3BS0701	E3BS0711	E3BS0721
E3BS0542	E3BS0552	E3BS0562	E3BS0572	E3BS0582	E3BS0592	E3BS0602	E3BS0612	E3BS0622	E3BS0632	E3BS0642	E3BS0652	E3BS0662	E3BS0672	E3BS0682	E3BS0692	E3BS0702	E3BS0712	E3BS0722
E3BS0543	E3BS0553	E3BS0563	E3BS0573	E3BS0583	E3BS0593	E3BS0603	E3BS0613	E3BS0623	E3BS0633	E3BS0643	E3BS0653	E3BS0663	E3BS0673	E3BS0683	E3BS0693	E3BS0703	E3BS0713	E3BS0723
E3BS0544	E3BS0554	E3BS0564	E3BS0574	E3BS0584	E3BS0594	E3BS0604	E3BS0614	E3BS0624	E3BS0634	E3BS0644	E3BS0654	E3BS0664	E3BS0674	E3BS0684	E3BS0694	E3BS0704	E3BS0714	E3BS0724
E3BS0545	E3BS0555	E3BS0565	E3BS0575	E3BS0585	E3BS0595	E3BS0605	E3BS0615	E3BS0625	E3BS0635	E3BS0645	E3BS0655	E3BS0665	E3BS0675	E3BS0685	E3BS0695	E3BS0705	E3BS0715	E3BS0725
E3BS0546	E3BS0556	E3BS0566	E3BS0576	E3BS0586	E3BS0596	E3BS0606	E3BS0616	E3BS0626	E3BS0636	E3BS0646	E3BS0656	E3BS0666	E3BS0676	E3BS0686	E3BS0696	E3BS0706	E3BS0716	E3BS0726
E3BS0547	E3BS0557	E3BS0567	E3BS0577	E3BS0587	E3BS0597	E3BS0607	E3BS0617	E3BS0627	E3BS0637	E3BS0647	E3BS0657	E3BS0667	E3BS0677	E3BS0687	E3BS0697	E3BS0707	E3BS0717	E3BS0727
E3BS0548	E3BS0558	E3BS0568	E3BS0578	E3BS0588	E3BS0598	E3BS0608	E3BS0618	E3BS0628	E3BS0638	E3BS0648	E3BS0658	E3BS0668	E3BS0678	E3BS0688	E3BS0698	E3BS0708	E3BS0718	E3BS0728
E3BS0549	E3BS0559	E3BS0569	E3BS0579	E3BS0589	E3BS0599	E3BS0609	E3BS0619	E3BS0629	E3BS0639	E3BS0649	E3BS0659	E3BS0669	E3BS0679	E3BS0689	E3BS0699	E3BS0709	E3BS0719	E3BS0729
E3BS0550	E3BS0560	E3BS0570	E3BS0580	E3BS0590	E3BS0600	E3BS0610	E3BS0620	E3BS0630	E3BS0640	E3BS0650	E3BS0660	E3BS0670	E3BS0680	E3BS0690	E3BS0700	E3BS0710	E3BS0720	E3BS0730

25 TYP. 200 TYP. 25 TYP.

20 TYP. 210 TYP. 20 TYP.

E3BS0541 ~ E3BS0730  
3/F ELEVATION A

25 TYP. 200 TYP. 25 TYP.

FLOOR LEVEL

E3BS0731	E3BS0741	E3BS0751	E3BS0761	E3BS0771	E3BS0781	E3BS0791	E3BS0801	E3BS0811	E3BS0821	E3BS0831	E3BS0841	E3BS0851	E3BS0861	E3BS0871	E3BS0881	E3BS0891	E3BS0901	E3BS0911	E3BS0921	E3BS0931	E3BS0941	E3BS0951	E3BS0961	E3BS0971	E3BS0981	E3BS0991	E3BS1001	E3BS1011	E3BS1021	E3BS1031	E3BS1041	E3BS1051
E3BS0732	E3BS0742	E3BS0752	E3BS0762	E3BS0772	E3BS0782	E3BS0792	E3BS0802	E3BS0812	E3BS0822	E3BS0832	E3BS0842	E3BS0852	E3BS0862	E3BS0872	E3BS0882	E3BS0892	E3BS0902	E3BS0912	E3BS0922	E3BS0932	E3BS0942	E3BS0952	E3BS0962	E3BS0972	E3BS0982	E3BS0992	E3BS1002	E3BS1012	E3BS1022	E3BS1032	E3BS1042	E3BS1052
E3BS0733	E3BS0743	E3BS0753	E3BS0763	E3BS0773	E3BS0783	E3BS0793	E3BS0803	E3BS0813	E3BS0823	E3BS0833	E3BS0843	E3BS0853	E3BS0863	E3BS0873	E3BS0883	E3BS0893	E3BS0903	E3BS0913	E3BS0923	E3BS0933	E3BS0943	E3BS0953	E3BS0963	E3BS0973	E3BS0983	E3BS0993	E3BS1003	E3BS1013	E3BS1023	E3BS1033	E3BS1043	E3BS1053
E3BS0734	E3BS0744	E3BS0754	E3BS0764	E3BS0774	E3BS0784	E3BS0794	E3BS0804	E3BS0814	E3BS0824	E3BS0834	E3BS0844	E3BS0854	E3BS0864	E3BS0874	E3BS0884	E3BS0894	E3BS0904	E3BS0914	E3BS0924	E3BS0934	E3BS0944	E3BS0954	E3BS0964	E3BS0974	E3BS0984	E3BS0994	E3BS1004	E3BS1014	E3BS1024	E3BS1034	E3BS1044	E3BS1054
E3BS0735	E3BS0745	E3BS0755	E3BS0765	E3BS0775	E3BS0785	E3BS0795	E3BS0805	E3BS0815	E3BS0825	E3BS0835	E3BS0845	E3BS0855	E3BS0865	E3BS0875	E3BS0885	E3BS0895	E3BS0905	E3BS0915	E3BS0925	E3BS0935	E3BS0945	E3BS0955	E3BS0965	E3BS0975	E3BS0985	E3BS0995	E3BS1005	E3BS1015	E3BS1025	E3BS1035	E3BS1045	E3BS1055
E3BS0736	E3BS0746	E3BS0756	E3BS0766	E3BS0776	E3BS0786	E3BS0796	E3BS0806	E3BS0816	E3BS0826	E3BS0836	E3BS0846	E3BS0856	E3BS0866	E3BS0876	E3BS0886	E3BS0896	E3BS0906	E3BS0916	E3BS0926	E3BS0936	E3BS0946	E3BS0956	E3BS0966	E3BS0976	E3BS0986	E3BS0996	E3BS1006	E3BS1016	E3BS1026	E3BS1036	E3BS1046	E3BS1056
E3BS0737	E3BS0747	E3BS0757	E3BS0767	E3BS0777	E3BS0787	E3BS0797	E3BS0807	E3BS0817	E3BS0827	E3BS0837	E3BS0847	E3BS0857	E3BS0867	E3BS0877	E3BS0887	E3BS0897	E3BS0907	E3BS0917	E3BS0927	E3BS0937	E3BS0947	E3BS0957	E3BS0967	E3BS0977	E3BS0987	E3BS0997	E3BS1007	E3BS1017	E3BS1027	E3BS1037	E3BS1047	E3BS1057
E3BS0738	E3BS0748	E3BS0758	E3BS0768	E3BS0778	E3BS0788	E3BS0798	E3BS0808	E3BS0818	E3BS0828	E3BS0838	E3BS0848	E3BS0858	E3BS0868	E3BS0878	E3BS0888	E3BS0898	E3BS0908	E3BS0918	E3BS0928	E3BS0938	E3BS0948	E3BS0958	E3BS0968	E3BS0978	E3BS0988	E3BS0998	E3BS1008	E3BS1018	E3BS1028	E3BS1038	E3BS1048	E3BS1058
E3BS0739	E3BS0749	E3BS0759	E3BS0769	E3BS0779	E3BS0789	E3BS0799	E3BS0809	E3BS0819	E3BS0829	E3BS0839	E3BS0849	E3BS0859	E3BS0869	E3BS0879	E3BS0889	E3BS0899	E3BS0909	E3BS0919	E3BS0929	E3BS0939	E3BS0949	E3BS0959	E3BS0969	E3BS0979	E3BS0989	E3BS0999	E3BS1009	E3BS1019	E3BS1029	E3BS1039	E3BS1049	E3BS1059
E3BS0740	E3BS0750	E3BS0760	E3BS0770	E3BS0780	E3BS0790	E3BS0800	E3BS0810	E3BS0820	E3BS0830	E3BS0840	E3BS0850	E3BS0860	E3BS0870	E3BS0880	E3BS0890	E3BS0900	E3BS0910	E3BS0920	E3BS0930	E3BS0940	E3BS0950	E3BS0960	E3BS0970	E3BS0980	E3BS0990	E3BS1000	E3BS1010	E3BS1020	E3BS1030	E3BS1040	E3BS1050	E3BS1060

20 TYP. 210 TYP. 20 TYP.

E3BS0731 ~ E3BS1060  
3/F ELEVATION B

FLOOR LEVEL

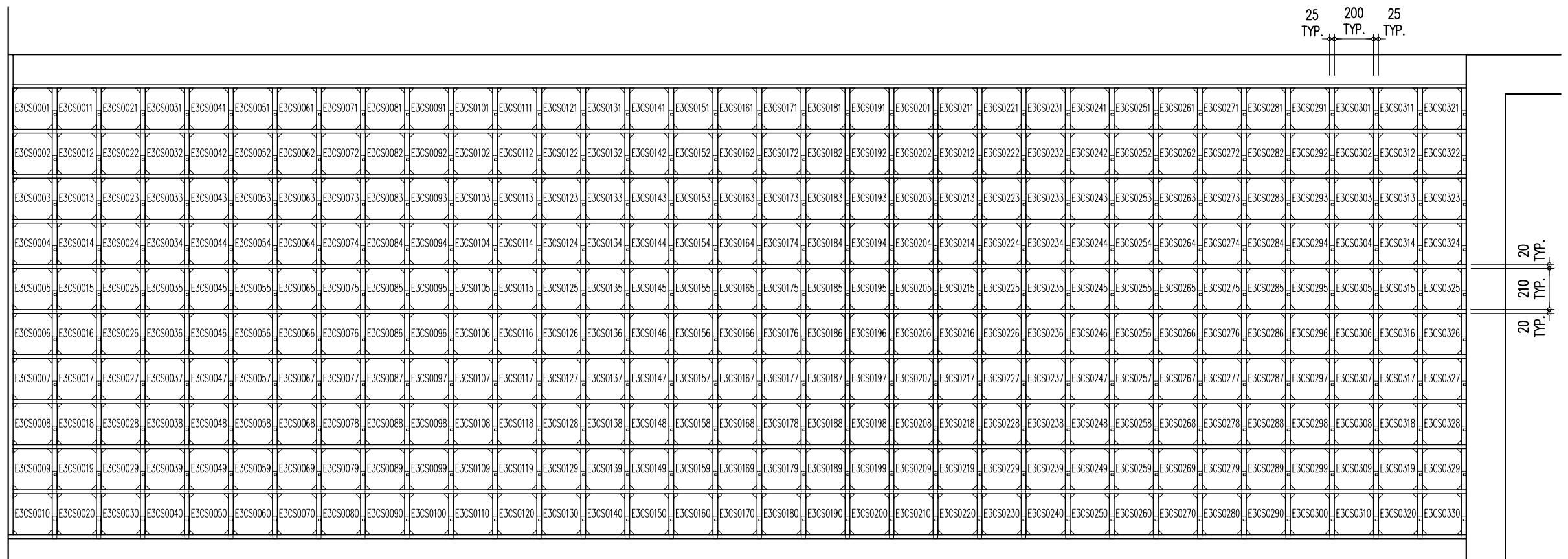

E3CS0001 ~ E3CS0330  
3/F ELEVATION A

25 TYP. 200 TYP. 25 TYP.

20 TYP. 210 TYP. 20 TYP.

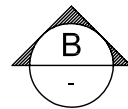
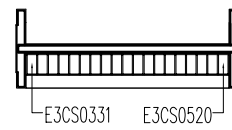
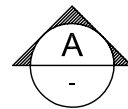
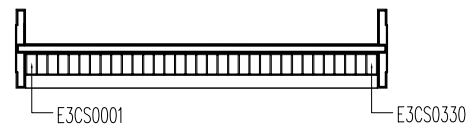

3/F FLOOR PLAN

FLOOR LEVEL

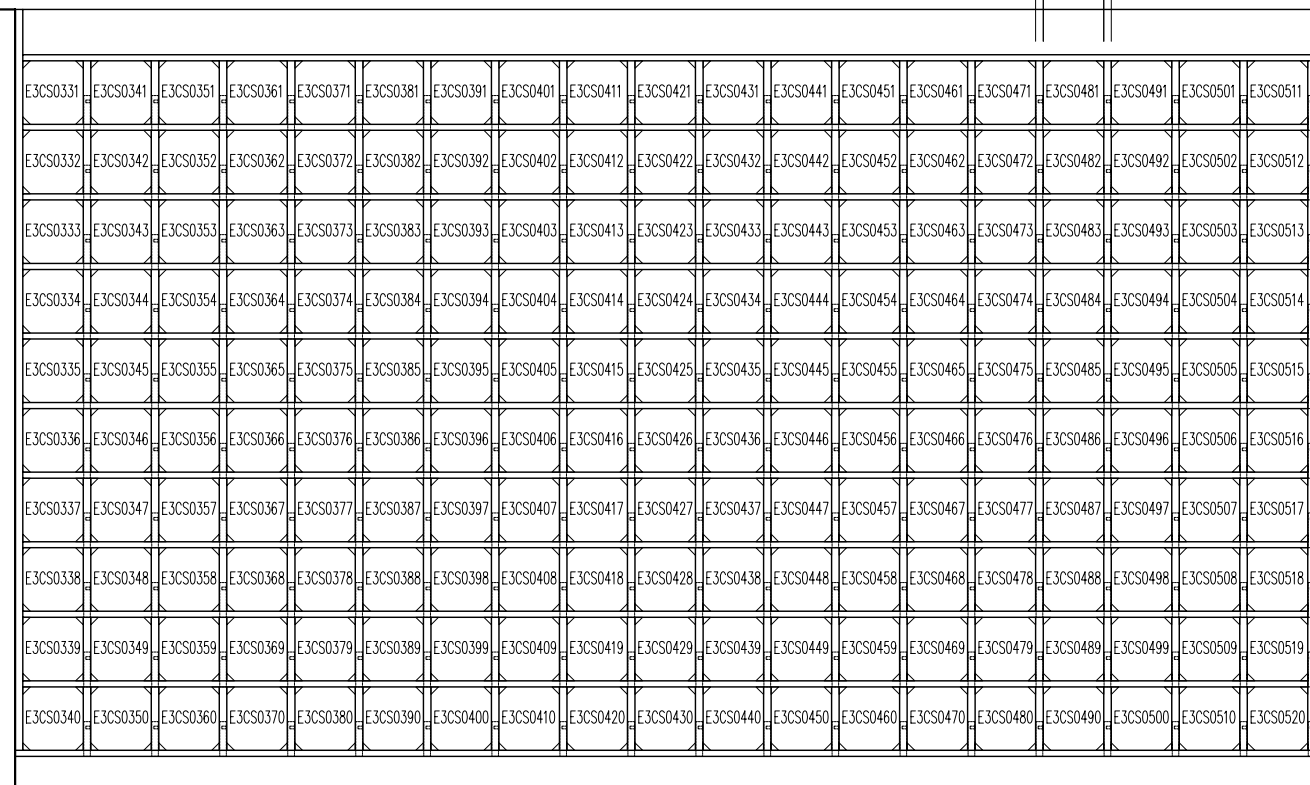

E3CS0331 ~ E3CS0520  
3/F ELEVATION B

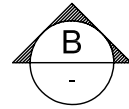
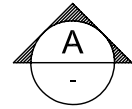
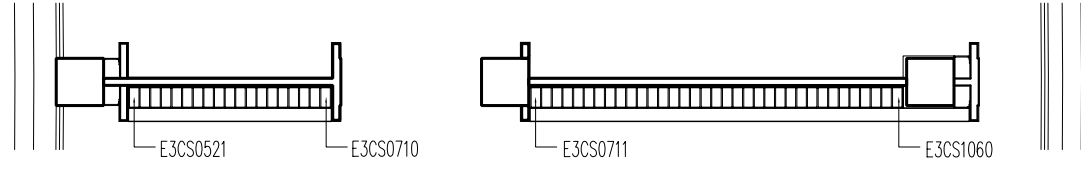

3/F FLOOR PLAN

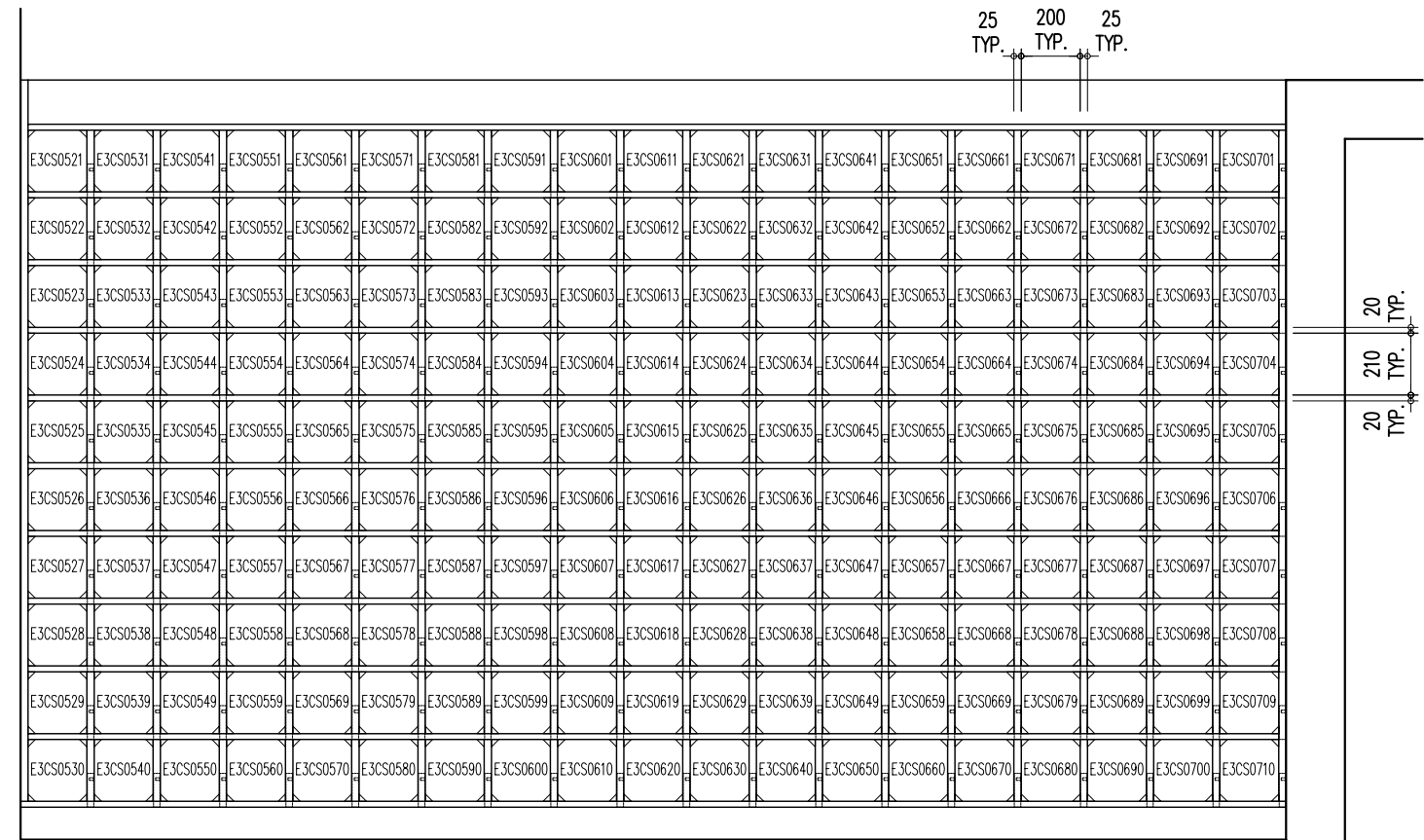

FLOOR LEVEL

E3CS0521 ~ E3CS0710  
3/F ELEVATION A

25 TYP. 200 TYP. 25 TYP.

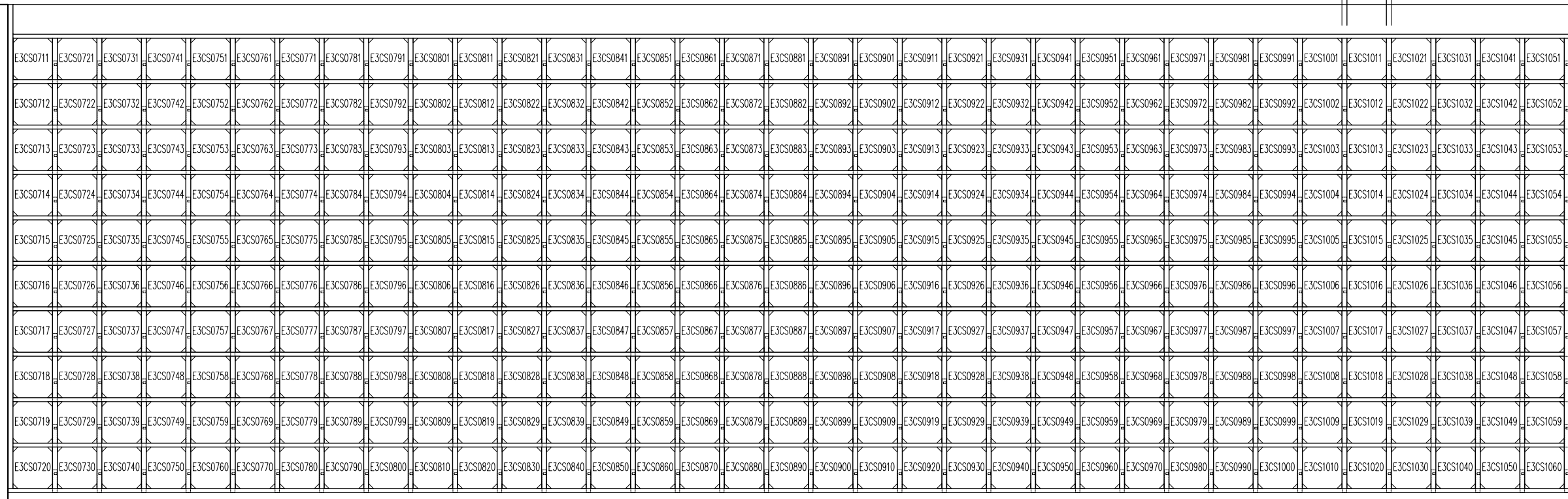

FLOOR LEVEL

E3CS0711 ~ E3CS1060  
3/F ELEVATION B

E3DS0001	E3DS0011	E3DS0021	E3DS0031	E3DS0041	E3DS0051	E3DS0061	E3DS0071	E3DS0081	E3DS0091	E3DS0101	E3DS0111	E3DS0121	E3DS0131	E3DS0141	E3DS0151	E3DS0161	E3DS0171	E3DS0181	E3DS0191	E3DS0201	E3DS0211	E3DS0221	E3DS0231	E3DS0241	E3DS0251	E3DS0261	E3DS0271	E3DS0281	E3DS0291	E3DS0301	E3DS0311	E3DS0321	E3DS0331	E3DS0341
E3DS0002	E3DS0012	E3DS0022	E3DS0032	E3DS0042	E3DS0052	E3DS0062	E3DS0072	E3DS0082	E3DS0092	E3DS0102	E3DS0112	E3DS0122	E3DS0132	E3DS0142	E3DS0152	E3DS0162	E3DS0172	E3DS0182	E3DS0192	E3DS0202	E3DS0212	E3DS0222	E3DS0232	E3DS0242	E3DS0252	E3DS0262	E3DS0272	E3DS0282	E3DS0292	E3DS0302	E3DS0312	E3DS0322	E3DS0332	E3DS0342
E3DS0003	E3DS0013	E3DS0023	E3DS0033	E3DS0043	E3DS0053	E3DS0063	E3DS0073	E3DS0083	E3DS0093	E3DS0103	E3DS0113	E3DS0123	E3DS0133	E3DS0143	E3DS0153	E3DS0163	E3DS0173	E3DS0183	E3DS0193	E3DS0203	E3DS0213	E3DS0223	E3DS0233	E3DS0243	E3DS0253	E3DS0263	E3DS0273	E3DS0283	E3DS0293	E3DS0303	E3DS0313	E3DS0323	E3DS0333	E3DS0343
E3DS0004	E3DS0014	E3DS0024	E3DS0034	E3DS0044	E3DS0054	E3DS0064	E3DS0074	E3DS0084	E3DS0094	E3DS0104	E3DS0114	E3DS0124	E3DS0134	E3DS0144	E3DS0154	E3DS0164	E3DS0174	E3DS0184	E3DS0194	E3DS0204	E3DS0214	E3DS0224	E3DS0234	E3DS0244	E3DS0254	E3DS0264	E3DS0274	E3DS0284	E3DS0294	E3DS0304	E3DS0314	E3DS0324	E3DS0334	E3DS0344
E3DS0005	E3DS0015	E3DS0025	E3DS0035	E3DS0045	E3DS0055	E3DS0065	E3DS0075	E3DS0085	E3DS0095	E3DS0105	E3DS0115	E3DS0125	E3DS0135	E3DS0145	E3DS0155	E3DS0165	E3DS0175	E3DS0185	E3DS0195	E3DS0205	E3DS0215	E3DS0225	E3DS0235	E3DS0245	E3DS0255	E3DS0265	E3DS0275	E3DS0285	E3DS0295	E3DS0305	E3DS0315	E3DS0325	E3DS0335	E3DS0345
E3DS0006	E3DS0016	E3DS0026	E3DS0036	E3DS0046	E3DS0056	E3DS0066	E3DS0076	E3DS0086	E3DS0096	E3DS0106	E3DS0116	E3DS0126	E3DS0136	E3DS0146	E3DS0156	E3DS0166	E3DS0176	E3DS0186	E3DS0196	E3DS0206	E3DS0216	E3DS0226	E3DS0236	E3DS0246	E3DS0256	E3DS0266	E3DS0276	E3DS0286	E3DS0296	E3DS0306	E3DS0316	E3DS0326	E3DS0336	E3DS0346
E3DS0007	E3DS0017	E3DS0027	E3DS0037	E3DS0047	E3DS0057	E3DS0067	E3DS0077	E3DS0087	E3DS0097	E3DS0107	E3DS0117	E3DS0127	E3DS0137	E3DS0147	E3DS0157	E3DS0167	E3DS0177	E3DS0187	E3DS0197	E3DS0207	E3DS0217	E3DS0227	E3DS0237	E3DS0247	E3DS0257	E3DS0267	E3DS0277	E3DS0287	E3DS0297	E3DS0307	E3DS0317	E3DS0327	E3DS0337	E3DS0347
E3DS0008	E3DS0018	E3DS0028	E3DS0038	E3DS0048	E3DS0058	E3DS0068	E3DS0078	E3DS0088	E3DS0098	E3DS0108	E3DS0118	E3DS0128	E3DS0138	E3DS0148	E3DS0158	E3DS0168	E3DS0178	E3DS0188	E3DS0198	E3DS0208	E3DS0218	E3DS0228	E3DS0238	E3DS0248	E3DS0258	E3DS0268	E3DS0278	E3DS0288	E3DS0298	E3DS0308	E3DS0318	E3DS0328	E3DS0338	E3DS0348
E3DS0009	E3DS0019	E3DS0029	E3DS0039	E3DS0049	E3DS0059	E3DS0069	E3DS0079	E3DS0089	E3DS0099	E3DS0109	E3DS0119	E3DS0129	E3DS0139	E3DS0149	E3DS0159	E3DS0169	E3DS0179	E3DS0189	E3DS0199	E3DS0209	E3DS0219	E3DS0229	E3DS0239	E3DS0249	E3DS0259	E3DS0269	E3DS0279	E3DS0289	E3DS0299	E3DS0309	E3DS0319	E3DS0329	E3DS0339	E3DS0349
E3DS0010	E3DS0020	E3DS0030	E3DS0040	E3DS0050	E3DS0060	E3DS0070	E3DS0080	E3DS0090	E3DS0100	E3DS0110	E3DS0120	E3DS0130	E3DS0140	E3DS0150	E3DS0160	E3DS0170	E3DS0180	E3DS0190	E3DS0200	E3DS0210	E3DS0220	E3DS0230	E3DS0240	E3DS0250	E3DS0260	E3DS0270	E3DS0280	E3DS0290	E3DS0300	E3DS0310	E3DS0320	E3DS0330	E3DS0340	E3DS0350

25 TYP. 200 TYP. 25 TYP.

20 TYP. 210 TYP. 20 TYP.

FLOOR LEVEL

E3DS0001 ~ E3DS0350  
3/F ELEVATION A

E3DS0351	E3DS0361	E3DS0371	E3DS0381	E3DS0391	E3DS0401	E3DS0411	E3DS0421	E3DS0431	E3DS0441	E3DS0451	E3DS0461	E3DS0471	E3DS0481	E3DS0491	E3DS0501	E3DS0511	E3DS0521	E3DS0531
E3DS0352	E3DS0362	E3DS0372	E3DS0382	E3DS0392	E3DS0402	E3DS0412	E3DS0422	E3DS0432	E3DS0442	E3DS0452	E3DS0462	E3DS0472	E3DS0482	E3DS0492	E3DS0502	E3DS0512	E3DS0522	E3DS0532
E3DS0353	E3DS0363	E3DS0373	E3DS0383	E3DS0393	E3DS0403	E3DS0413	E3DS0423	E3DS0433	E3DS0443	E3DS0453	E3DS0463	E3DS0473	E3DS0483	E3DS0493	E3DS0503	E3DS0513	E3DS0523	E3DS0533
E3DS0354	E3DS0364	E3DS0374	E3DS0384	E3DS0394	E3DS0404	E3DS0414	E3DS0424	E3DS0434	E3DS0444	E3DS0454	E3DS0464	E3DS0474	E3DS0484	E3DS0494	E3DS0504	E3DS0514	E3DS0524	E3DS0534
E3DS0355	E3DS0365	E3DS0375	E3DS0385	E3DS0395	E3DS0405	E3DS0415	E3DS0425	E3DS0435	E3DS0445	E3DS0455	E3DS0465	E3DS0475	E3DS0485	E3DS0495	E3DS0505	E3DS0515	E3DS0525	E3DS0535
E3DS0356	E3DS0366	E3DS0376	E3DS0386	E3DS0396	E3DS0406	E3DS0416	E3DS0426	E3DS0436	E3DS0446	E3DS0456	E3DS0466	E3DS0476	E3DS0486	E3DS0496	E3DS0506	E3DS0516	E3DS0526	E3DS0536
E3DS0357	E3DS0367	E3DS0377	E3DS0387	E3DS0397	E3DS0407	E3DS0417	E3DS0427	E3DS0437	E3DS0447	E3DS0457	E3DS0467	E3DS0477	E3DS0487	E3DS0497	E3DS0507	E3DS0517	E3DS0527	E3DS0537
E3DS0358	E3DS0368	E3DS0378	E3DS0388	E3DS0398	E3DS0408	E3DS0418	E3DS0428	E3DS0438	E3DS0448	E3DS0458	E3DS0468	E3DS0478	E3DS0488	E3DS0498	E3DS0508	E3DS0518	E3DS0528	E3DS0538
E3DS0359	E3DS0369	E3DS0379	E3DS0389	E3DS0399	E3DS0409	E3DS0419	E3DS0429	E3DS0439	E3DS0449	E3DS0459	E3DS0469	E3DS0479	E3DS0489	E3DS0499	E3DS0509	E3DS0519	E3DS0529	E3DS0539
E3DS0360	E3DS0370	E3DS0380	E3DS0390	E3DS0400	E3DS0410	E3DS0420	E3DS0430	E3DS0440	E3DS0450	E3DS0460	E3DS0470	E3DS0480	E3DS0490	E3DS0500	E3DS0510	E3DS0520	E3DS0530	E3DS0540

25 TYP. 200 TYP. 25 TYP.

20 TYP. 210 TYP. 20 TYP.

FLOOR LEVEL

E3DS0351 ~ E3DS0540  
3/F ELEVATION B

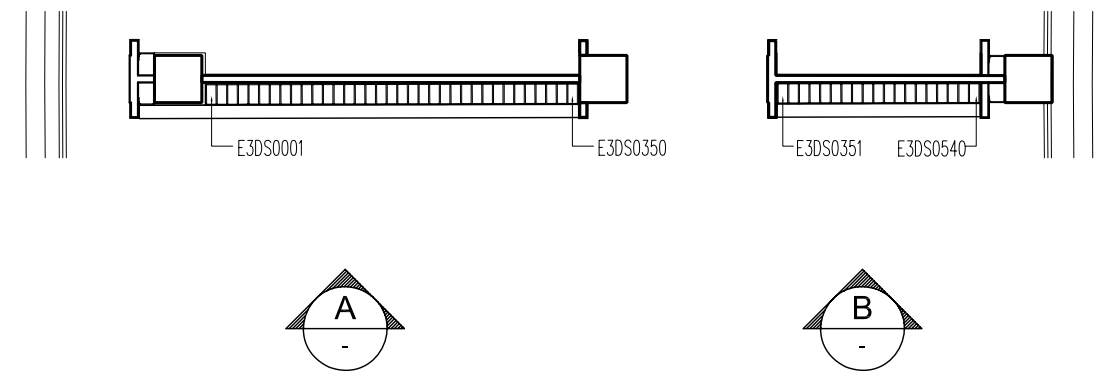

3/F FLOOR PLAN

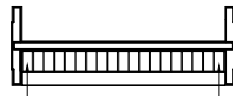

E3DS0541 E3DS0730

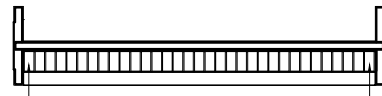

E3DS0731 E3DS1060

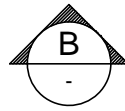
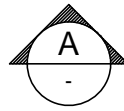

### 3/F FLOOR PLAN

FLOOR LEVEL

E3DS0541	E3DS0551	E3DS0561	E3DS0571	E3DS0581	E3DS0591	E3DS0601	E3DS0611	E3DS0621	E3DS0631	E3DS0641	E3DS0651	E3DS0661	E3DS0671	E3DS0681	E3DS0691	E3DS0701	E3DS0711	E3DS0721
E3DS0542	E3DS0552	E3DS0562	E3DS0572	E3DS0582	E3DS0592	E3DS0602	E3DS0612	E3DS0622	E3DS0632	E3DS0642	E3DS0652	E3DS0662	E3DS0672	E3DS0682	E3DS0692	E3DS0702	E3DS0712	E3DS0722
E3DS0543	E3DS0553	E3DS0563	E3DS0573	E3DS0583	E3DS0593	E3DS0603	E3DS0613	E3DS0623	E3DS0633	E3DS0643	E3DS0653	E3DS0663	E3DS0673	E3DS0683	E3DS0693	E3DS0703	E3DS0713	E3DS0723
E3DS0544	E3DS0554	E3DS0564	E3DS0574	E3DS0584	E3DS0594	E3DS0604	E3DS0614	E3DS0624	E3DS0634	E3DS0644	E3DS0654	E3DS0664	E3DS0674	E3DS0684	E3DS0694	E3DS0704	E3DS0714	E3DS0724
E3DS0545	E3DS0555	E3DS0565	E3DS0575	E3DS0585	E3DS0595	E3DS0605	E3DS0615	E3DS0625	E3DS0635	E3DS0645	E3DS0655	E3DS0665	E3DS0675	E3DS0685	E3DS0695	E3DS0705	E3DS0715	E3DS0725
E3DS0546	E3DS0556	E3DS0566	E3DS0576	E3DS0586	E3DS0596	E3DS0606	E3DS0616	E3DS0626	E3DS0636	E3DS0646	E3DS0656	E3DS0666	E3DS0676	E3DS0686	E3DS0696	E3DS0706	E3DS0716	E3DS0726
E3DS0547	E3DS0557	E3DS0567	E3DS0577	E3DS0587	E3DS0597	E3DS0607	E3DS0617	E3DS0627	E3DS0637	E3DS0647	E3DS0657	E3DS0667	E3DS0677	E3DS0687	E3DS0697	E3DS0707	E3DS0717	E3DS0727
E3DS0548	E3DS0558	E3DS0568	E3DS0578	E3DS0588	E3DS0598	E3DS0608	E3DS0618	E3DS0628	E3DS0638	E3DS0648	E3DS0658	E3DS0668	E3DS0678	E3DS0688	E3DS0698	E3DS0708	E3DS0718	E3DS0728
E3DS0549	E3DS0559	E3DS0569	E3DS0579	E3DS0589	E3DS0599	E3DS0609	E3DS0619	E3DS0629	E3DS0639	E3DS0649	E3DS0659	E3DS0669	E3DS0679	E3DS0689	E3DS0699	E3DS0709	E3DS0719	E3DS0729
E3DS0550	E3DS0560	E3DS0570	E3DS0580	E3DS0590	E3DS0600	E3DS0610	E3DS0620	E3DS0630	E3DS0640	E3DS0650	E3DS0660	E3DS0670	E3DS0680	E3DS0690	E3DS0700	E3DS0710	E3DS0720	E3DS0730

25 TYP. 200 TYP. 25 TYP.

20 TYP. 210 TYP. 20 TYP.

### E3DS0541 ~ E3DS0730 3/F ELEVATION A

25 TYP. 200 TYP. 25 TYP.

FLOOR LEVEL

E3DS0731	E3DS0741	E3DS0751	E3DS0761	E3DS0771	E3DS0781	E3DS0791	E3DS0801	E3DS0811	E3DS0821	E3DS0831	E3DS0841	E3DS0851	E3DS0861	E3DS0871	E3DS0881	E3DS0891	E3DS0901	E3DS0911	E3DS0921	E3DS0931	E3DS0941	E3DS0951	E3DS0961	E3DS0971	E3DS0981	E3DS0991	E3DS1001	E3DS1011	E3DS1021	E3DS1031	E3DS1041	E3DS1051
E3DS0732	E3DS0742	E3DS0752	E3DS0762	E3DS0772	E3DS0782	E3DS0792	E3DS0802	E3DS0812	E3DS0822	E3DS0832	E3DS0842	E3DS0852	E3DS0862	E3DS0872	E3DS0882	E3DS0892	E3DS0902	E3DS0912	E3DS0922	E3DS0932	E3DS0942	E3DS0952	E3DS0962	E3DS0972	E3DS0982	E3DS0992	E3DS1002	E3DS1012	E3DS1022	E3DS1032	E3DS1042	E3DS1052
E3DS0733	E3DS0743	E3DS0753	E3DS0763	E3DS0773	E3DS0783	E3DS0793	E3DS0803	E3DS0813	E3DS0823	E3DS0833	E3DS0843	E3DS0853	E3DS0863	E3DS0873	E3DS0883	E3DS0893	E3DS0903	E3DS0913	E3DS0923	E3DS0933	E3DS0943	E3DS0953	E3DS0963	E3DS0973	E3DS0983	E3DS0993	E3DS1003	E3DS1013	E3DS1023	E3DS1033	E3DS1043	E3DS1053
E3DS0734	E3DS0744	E3DS0754	E3DS0764	E3DS0774	E3DS0784	E3DS0794	E3DS0804	E3DS0814	E3DS0824	E3DS0834	E3DS0844	E3DS0854	E3DS0864	E3DS0874	E3DS0884	E3DS0894	E3DS0904	E3DS0914	E3DS0924	E3DS0934	E3DS0944	E3DS0954	E3DS0964	E3DS0974	E3DS0984	E3DS0994	E3DS1004	E3DS1014	E3DS1024	E3DS1034	E3DS1044	E3DS1054
E3DS0735	E3DS0745	E3DS0755	E3DS0765	E3DS0775	E3DS0785	E3DS0795	E3DS0805	E3DS0815	E3DS0825	E3DS0835	E3DS0845	E3DS0855	E3DS0865	E3DS0875	E3DS0885	E3DS0895	E3DS0905	E3DS0915	E3DS0925	E3DS0935	E3DS0945	E3DS0955	E3DS0965	E3DS0975	E3DS0985	E3DS0995	E3DS1005	E3DS1015	E3DS1025	E3DS1035	E3DS1045	E3DS1055
E3DS0736	E3DS0746	E3DS0756	E3DS0766	E3DS0776	E3DS0786	E3DS0796	E3DS0806	E3DS0816	E3DS0826	E3DS0836	E3DS0846	E3DS0856	E3DS0866	E3DS0876	E3DS0886	E3DS0896	E3DS0906	E3DS0916	E3DS0926	E3DS0936	E3DS0946	E3DS0956	E3DS0966	E3DS0976	E3DS0986	E3DS0996	E3DS1006	E3DS1016	E3DS1026	E3DS1036	E3DS1046	E3DS1056
E3DS0737	E3DS0747	E3DS0757	E3DS0767	E3DS0777	E3DS0787	E3DS0797	E3DS0807	E3DS0817	E3DS0827	E3DS0837	E3DS0847	E3DS0857	E3DS0867	E3DS0877	E3DS0887	E3DS0897	E3DS0907	E3DS0917	E3DS0927	E3DS0937	E3DS0947	E3DS0957	E3DS0967	E3DS0977	E3DS0987	E3DS0997	E3DS1007	E3DS1017	E3DS1027	E3DS1037	E3DS1047	E3DS1057
E3DS0738	E3DS0748	E3DS0758	E3DS0768	E3DS0778	E3DS0788	E3DS0798	E3DS0808	E3DS0818	E3DS0828	E3DS0838	E3DS0848	E3DS0858	E3DS0868	E3DS0878	E3DS0888	E3DS0898	E3DS0908	E3DS0918	E3DS0928	E3DS0938	E3DS0948	E3DS0958	E3DS0968	E3DS0978	E3DS0988	E3DS0998	E3DS1008	E3DS1018	E3DS1028	E3DS1038	E3DS1048	E3DS1058
E3DS0739	E3DS0749	E3DS0759	E3DS0769	E3DS0779	E3DS0789	E3DS0799	E3DS0809	E3DS0819	E3DS0829	E3DS0839	E3DS0849	E3DS0859	E3DS0869	E3DS0879	E3DS0889	E3DS0899	E3DS0909	E3DS0919	E3DS0929	E3DS0939	E3DS0949	E3DS0959	E3DS0969	E3DS0979	E3DS0989	E3DS0999	E3DS1009	E3DS1019	E3DS1029	E3DS1039	E3DS1049	E3DS1059
E3DS0740	E3DS0750	E3DS0760	E3DS0770	E3DS0780	E3DS0790	E3DS0800	E3DS0810	E3DS0820	E3DS0830	E3DS0840	E3DS0850	E3DS0860	E3DS0870	E3DS0880	E3DS0890	E3DS0900	E3DS0910	E3DS0920	E3DS0930	E3DS0940	E3DS0950	E3DS0960	E3DS0970	E3DS0980	E3DS0990	E3DS1000	E3DS1010	E3DS1020	E3DS1030	E3DS1040	E3DS1050	E3DS1060

20 TYP. 210 TYP. 20 TYP.

### E3DS0731 ~ E3DS1060 3/F ELEVATION B



FLOOR LEVEL

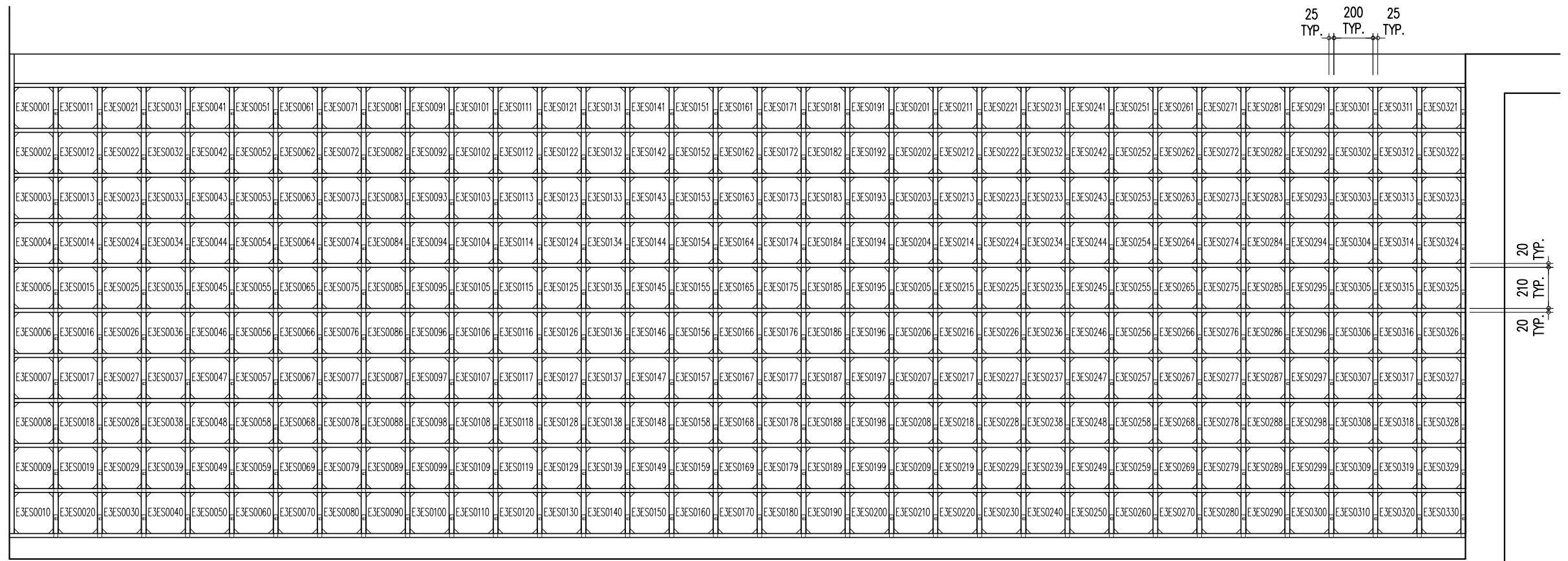

E3ES0001 ~ E3ES0330  
3/F ELEVATION A

25 TYP. 200 TYP. 25 TYP.

20 TYP. 210 TYP. 20 TYP.

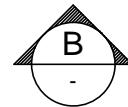
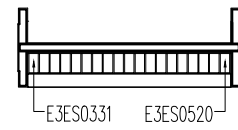
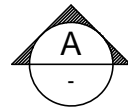
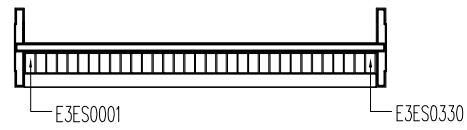

3/F FLOOR PLAN

FLOOR LEVEL

E3ES0331 ~ E3ES0520  
3/F ELEVATION B

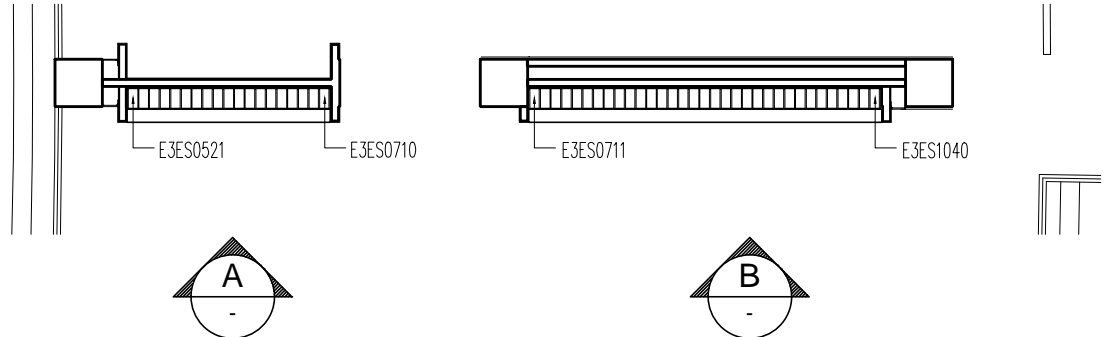

3/F FLOOR PLAN

E3ES0521	E3ES0531	E3ES0541	E3ES0551	E3ES0561	E3ES0571	E3ES0581	E3ES0591	E3ES0601	E3ES0611	E3ES0621	E3ES0631	E3ES0641	E3ES0651	E3ES0661	E3ES0671	E3ES0681	E3ES0691	E3ES0701
E3ES0522	E3ES0532	E3ES0542	E3ES0552	E3ES0562	E3ES0572	E3ES0582	E3ES0592	E3ES0602	E3ES0612	E3ES0622	E3ES0632	E3ES0642	E3ES0652	E3ES0662	E3ES0672	E3ES0682	E3ES0692	E3ES0702
E3ES0523	E3ES0533	E3ES0543	E3ES0553	E3ES0563	E3ES0573	E3ES0583	E3ES0593	E3ES0603	E3ES0613	E3ES0623	E3ES0633	E3ES0643	E3ES0653	E3ES0663	E3ES0673	E3ES0683	E3ES0693	E3ES0703
E3ES0524	E3ES0534	E3ES0544	E3ES0554	E3ES0564	E3ES0574	E3ES0584	E3ES0594	E3ES0604	E3ES0614	E3ES0624	E3ES0634	E3ES0644	E3ES0654	E3ES0664	E3ES0674	E3ES0684	E3ES0694	E3ES0704
E3ES0525	E3ES0535	E3ES0545	E3ES0555	E3ES0565	E3ES0575	E3ES0585	E3ES0595	E3ES0605	E3ES0615	E3ES0625	E3ES0635	E3ES0645	E3ES0655	E3ES0665	E3ES0675	E3ES0685	E3ES0695	E3ES0705
E3ES0526	E3ES0536	E3ES0546	E3ES0556	E3ES0566	E3ES0576	E3ES0586	E3ES0596	E3ES0606	E3ES0616	E3ES0626	E3ES0636	E3ES0646	E3ES0656	E3ES0666	E3ES0676	E3ES0686	E3ES0696	E3ES0706
E3ES0527	E3ES0537	E3ES0547	E3ES0557	E3ES0567	E3ES0577	E3ES0587	E3ES0597	E3ES0607	E3ES0617	E3ES0627	E3ES0637	E3ES0647	E3ES0657	E3ES0667	E3ES0677	E3ES0687	E3ES0697	E3ES0707
E3ES0528	E3ES0538	E3ES0548	E3ES0558	E3ES0568	E3ES0578	E3ES0588	E3ES0598	E3ES0608	E3ES0618	E3ES0628	E3ES0638	E3ES0648	E3ES0658	E3ES0668	E3ES0678	E3ES0688	E3ES0698	E3ES0708
E3ES0529	E3ES0539	E3ES0549	E3ES0559	E3ES0569	E3ES0579	E3ES0589	E3ES0599	E3ES0609	E3ES0619	E3ES0629	E3ES0639	E3ES0649	E3ES0659	E3ES0669	E3ES0679	E3ES0689	E3ES0699	E3ES0709
E3ES0530	E3ES0540	E3ES0550	E3ES0560	E3ES0570	E3ES0580	E3ES0590	E3ES0600	E3ES0610	E3ES0620	E3ES0630	E3ES0640	E3ES0650	E3ES0660	E3ES0670	E3ES0680	E3ES0690	E3ES0700	E3ES0710

25 TYP. 200 TYP. 25 TYP.

20 TYP.  
210 TYP.  
20 TYP.

FLOOR LEVEL

E3ES0521 ~ E3ES0710  
3/F ELEVATION A

25 TYP. 200 TYP. 25 TYP.

E3ES0711	E3ES0721	E3ES0731	E3ES0741	E3ES0751	E3ES0761	E3ES0771	E3ES0781	E3ES0791	E3ES0801	E3ES0811	E3ES0821	E3ES0831	E3ES0841	E3ES0851	E3ES0861	E3ES0871	E3ES0881	E3ES0891	E3ES0901	E3ES0911	E3ES0921	E3ES0931	E3ES0941	E3ES0951	E3ES0961	E3ES0971	E3ES0981	E3ES0991	E3ES1001	E3ES1011	E3ES1021	E3ES1031
E3ES0712	E3ES0722	E3ES0732	E3ES0742	E3ES0752	E3ES0762	E3ES0772	E3ES0782	E3ES0792	E3ES0802	E3ES0812	E3ES0822	E3ES0832	E3ES0842	E3ES0852	E3ES0862	E3ES0872	E3ES0882	E3ES0892	E3ES0902	E3ES0912	E3ES0922	E3ES0932	E3ES0942	E3ES0952	E3ES0962	E3ES0972	E3ES0982	E3ES0992	E3ES1002	E3ES1012	E3ES1022	E3ES1032
E3ES0713	E3ES0723	E3ES0733	E3ES0743	E3ES0753	E3ES0763	E3ES0773	E3ES0783	E3ES0793	E3ES0803	E3ES0813	E3ES0823	E3ES0833	E3ES0843	E3ES0853	E3ES0863	E3ES0873	E3ES0883	E3ES0893	E3ES0903	E3ES0913	E3ES0923	E3ES0933	E3ES0943	E3ES0953	E3ES0963	E3ES0973	E3ES0983	E3ES0993	E3ES1003	E3ES1013	E3ES1023	E3ES1033
E3ES0714	E3ES0724	E3ES0734	E3ES0744	E3ES0754	E3ES0764	E3ES0774	E3ES0784	E3ES0794	E3ES0804	E3ES0814	E3ES0824	E3ES0834	E3ES0844	E3ES0854	E3ES0864	E3ES0874	E3ES0884	E3ES0894	E3ES0904	E3ES0914	E3ES0924	E3ES0934	E3ES0944	E3ES0954	E3ES0964	E3ES0974	E3ES0984	E3ES0994	E3ES1004	E3ES1014	E3ES1024	E3ES1034
E3ES0715	E3ES0725	E3ES0735	E3ES0745	E3ES0755	E3ES0765	E3ES0775	E3ES0785	E3ES0795	E3ES0805	E3ES0815	E3ES0825	E3ES0835	E3ES0845	E3ES0855	E3ES0865	E3ES0875	E3ES0885	E3ES0895	E3ES0905	E3ES0915	E3ES0925	E3ES0935	E3ES0945	E3ES0955	E3ES0965	E3ES0975	E3ES0985	E3ES0995	E3ES1005	E3ES1015	E3ES1025	E3ES1035
E3ES0716	E3ES0726	E3ES0736	E3ES0746	E3ES0756	E3ES0766	E3ES0776	E3ES0786	E3ES0796	E3ES0806	E3ES0816	E3ES0826	E3ES0836	E3ES0846	E3ES0856	E3ES0866	E3ES0876	E3ES0886	E3ES0896	E3ES0906	E3ES0916	E3ES0926	E3ES0936	E3ES0946	E3ES0956	E3ES0966	E3ES0976	E3ES0986	E3ES0996	E3ES1006	E3ES1016	E3ES1026	E3ES1036
E3ES0717	E3ES0727	E3ES0737	E3ES0747	E3ES0757	E3ES0767	E3ES0777	E3ES0787	E3ES0797	E3ES0807	E3ES0817	E3ES0827	E3ES0837	E3ES0847	E3ES0857	E3ES0867	E3ES0877	E3ES0887	E3ES0897	E3ES0907	E3ES0917	E3ES0927	E3ES0937	E3ES0947	E3ES0957	E3ES0967	E3ES0977	E3ES0987	E3ES0997	E3ES1007	E3ES1017	E3ES1027	E3ES1037
E3ES0718	E3ES0728	E3ES0738	E3ES0748	E3ES0758	E3ES0768	E3ES0778	E3ES0788	E3ES0798	E3ES0808	E3ES0818	E3ES0828	E3ES0838	E3ES0848	E3ES0858	E3ES0868	E3ES0878	E3ES0888	E3ES0898	E3ES0908	E3ES0918	E3ES0928	E3ES0938	E3ES0948	E3ES0958	E3ES0968	E3ES0978	E3ES0988	E3ES0998	E3ES1008	E3ES1018	E3ES1028	E3ES1038
E3ES0719	E3ES0729	E3ES0739	E3ES0749	E3ES0759	E3ES0769	E3ES0779	E3ES0789	E3ES0799	E3ES0809	E3ES0819	E3ES0829	E3ES0839	E3ES0849	E3ES0859	E3ES0869	E3ES0879	E3ES0889	E3ES0899	E3ES0909	E3ES0919	E3ES0929	E3ES0939	E3ES0949	E3ES0959	E3ES0969	E3ES0979	E3ES0989	E3ES0999	E3ES1009	E3ES1019	E3ES1029	E3ES1039
E3ES0720	E3ES0730	E3ES0740	E3ES0750	E3ES0760	E3ES0770	E3ES0780	E3ES0790	E3ES0800	E3ES0810	E3ES0820	E3ES0830	E3ES0840	E3ES0850	E3ES0860	E3ES0870	E3ES0880	E3ES0890	E3ES0900	E3ES0910	E3ES0920	E3ES0930	E3ES0940	E3ES0950	E3ES0960	E3ES0970	E3ES0980	E3ES0990	E3ES1000	E3ES1010	E3ES1020	E3ES1030	E3ES1040

20 TYP.  
210 TYP.  
20 TYP.

FLOOR LEVEL

E3ES0711 ~ E3ES1040  
3/F ELEVATION B

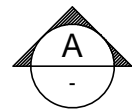
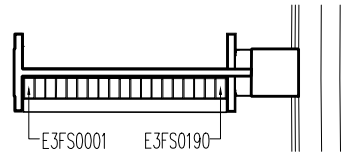

3/F FLOOR PLAN

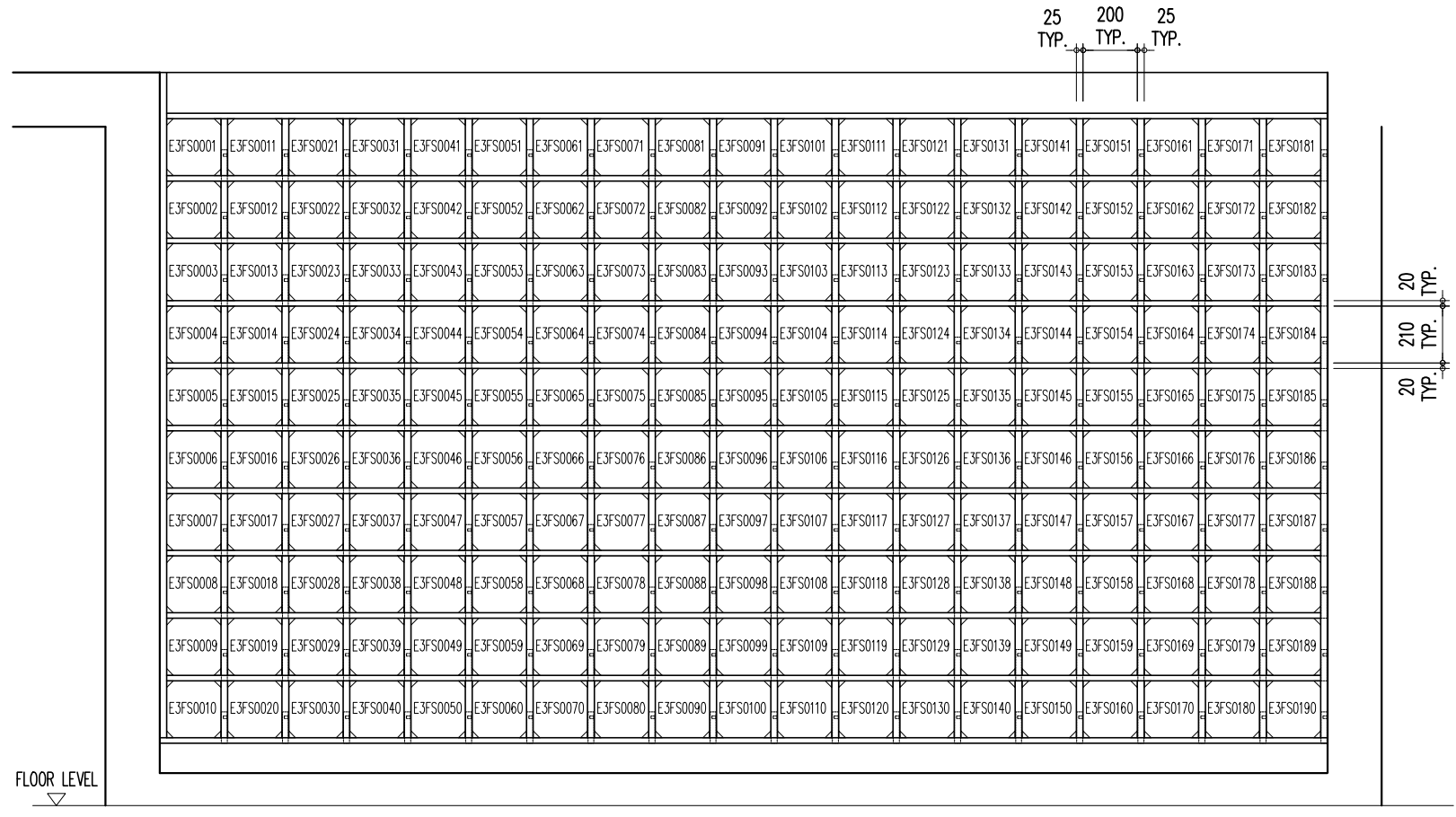

E3FS0001 ~ E3FS0190  
3/F ELEVATION A

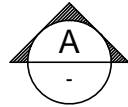
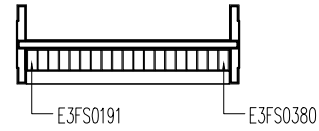

3/F FLOOR PLAN

FLOOR LEVEL  
▽

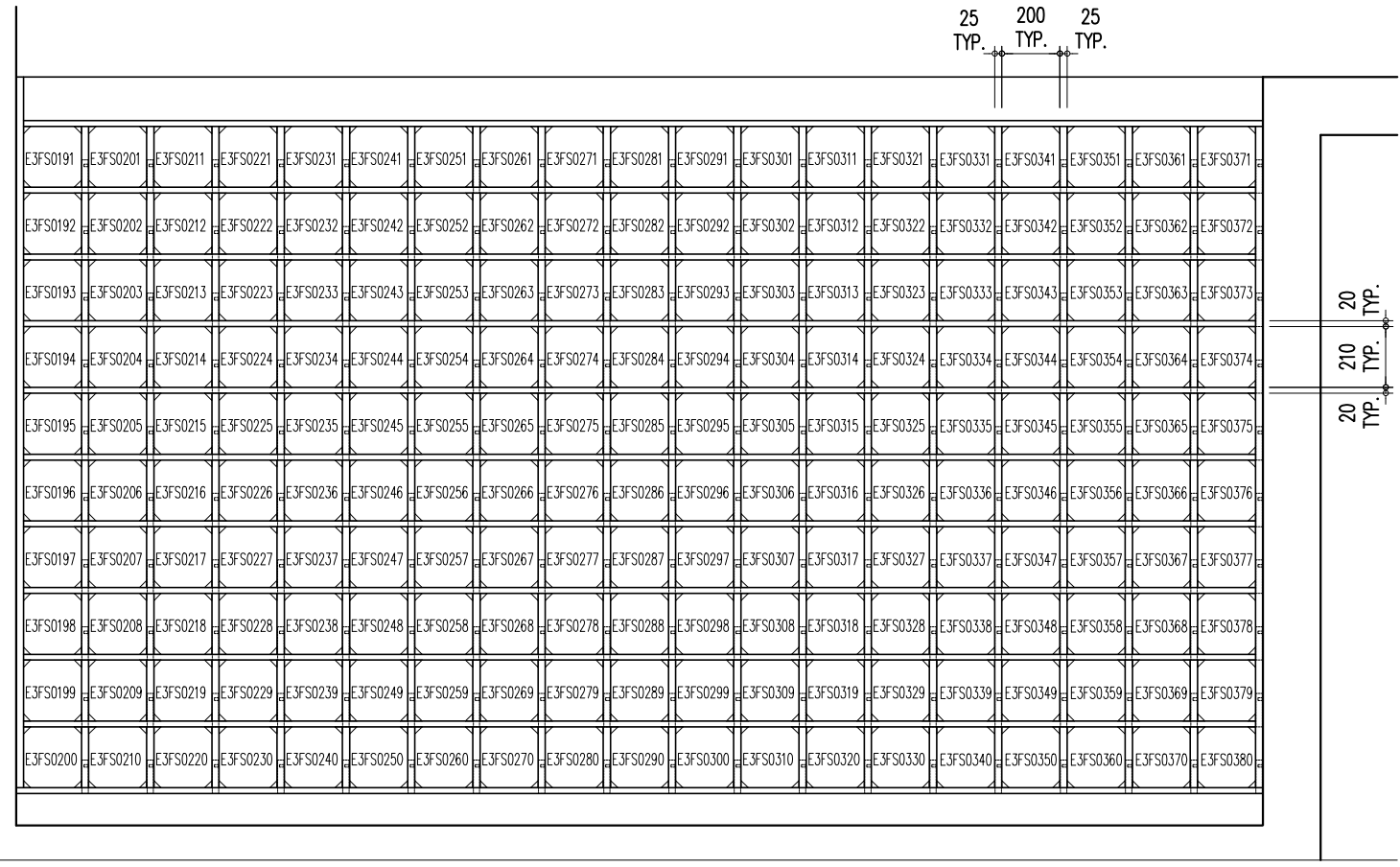

E.3FS0191 ~ E.3FS0380  
3/F ELEVATION A

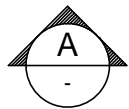
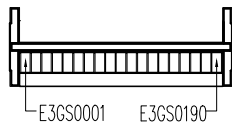

3/F FLOOR PLAN

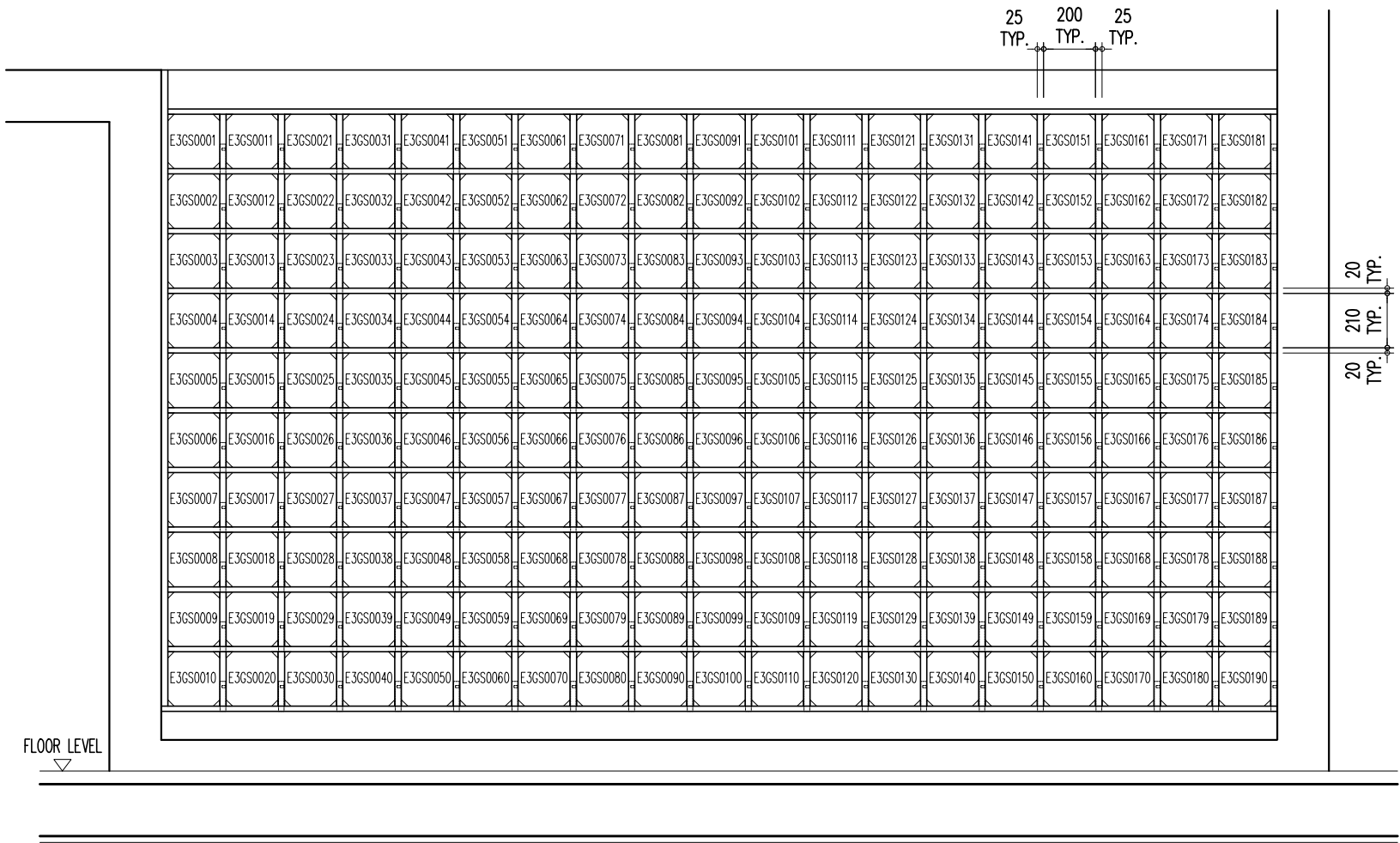

E3GS0001 ~ E3GS0190  
3/F ELEVATION A

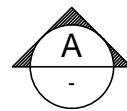
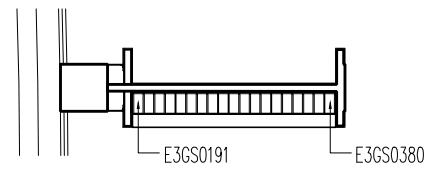

3/F FLOOR PLAN

FLOOR LEVEL  
▽

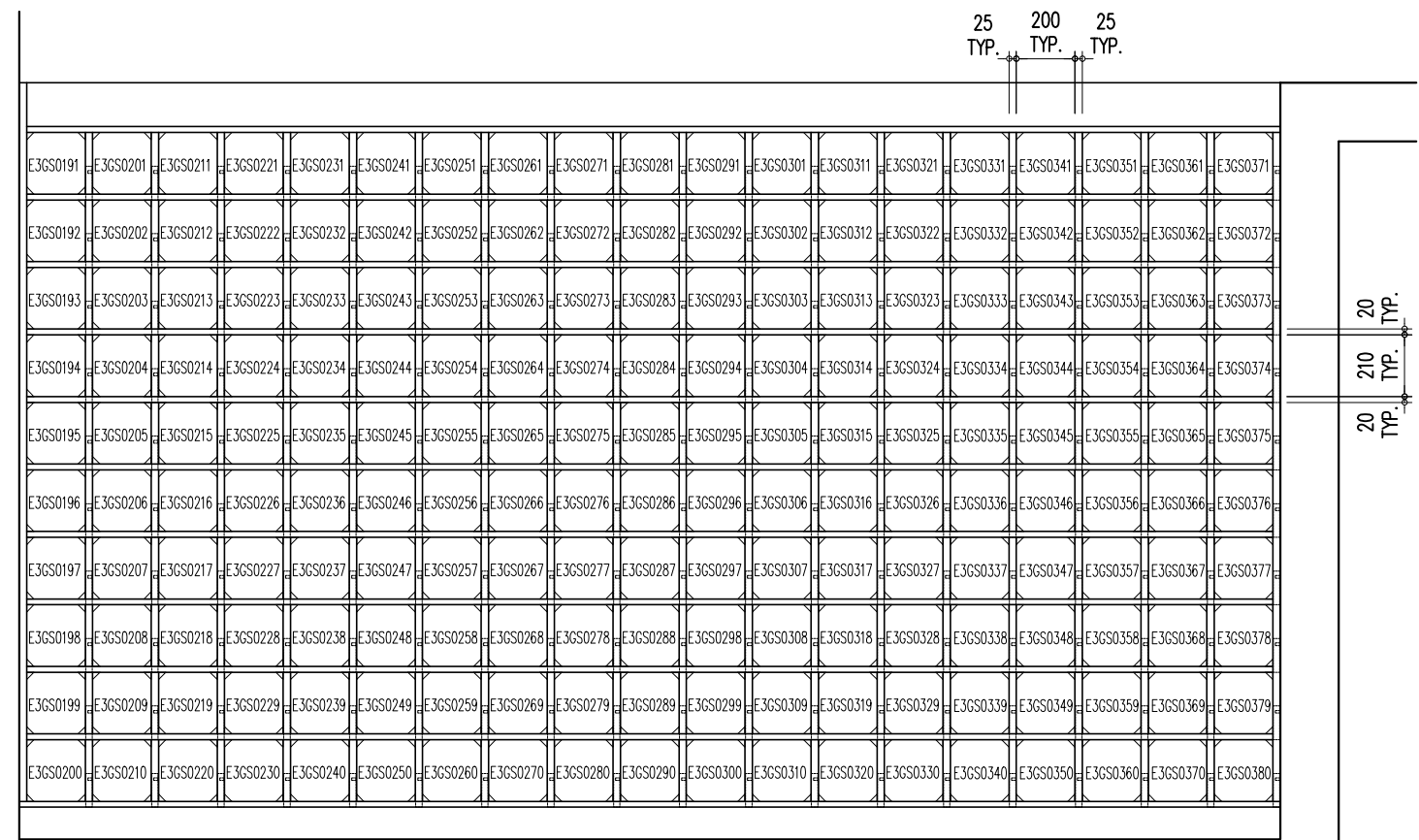

E3GS0191~ E3GS0380  
3/F ELEVATION A

FLOOR LEVEL

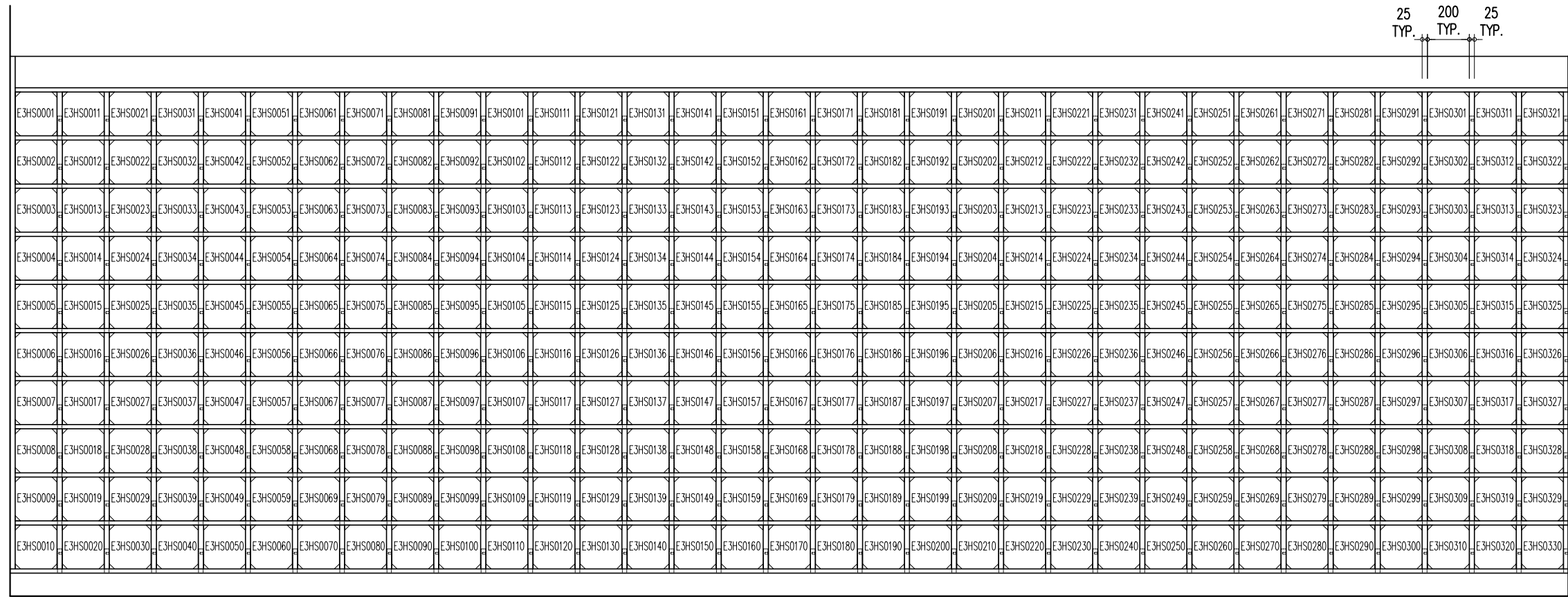

E3HS0001 ~ E3HS0330  
3/F ELEVATION A

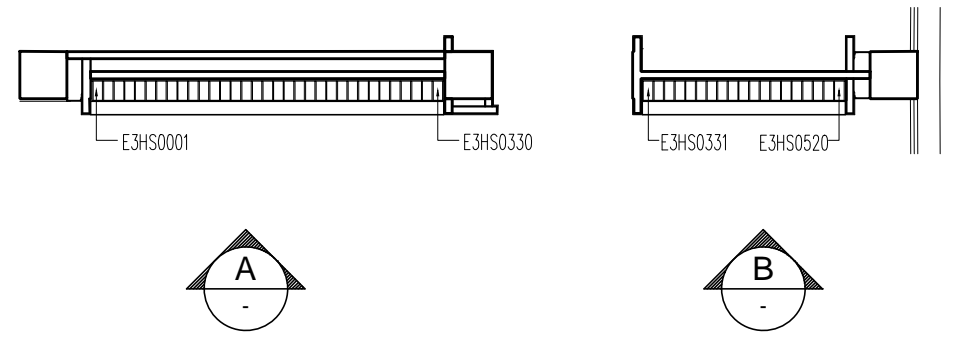

3/F FLOOR PLAN

FLOOR LEVEL

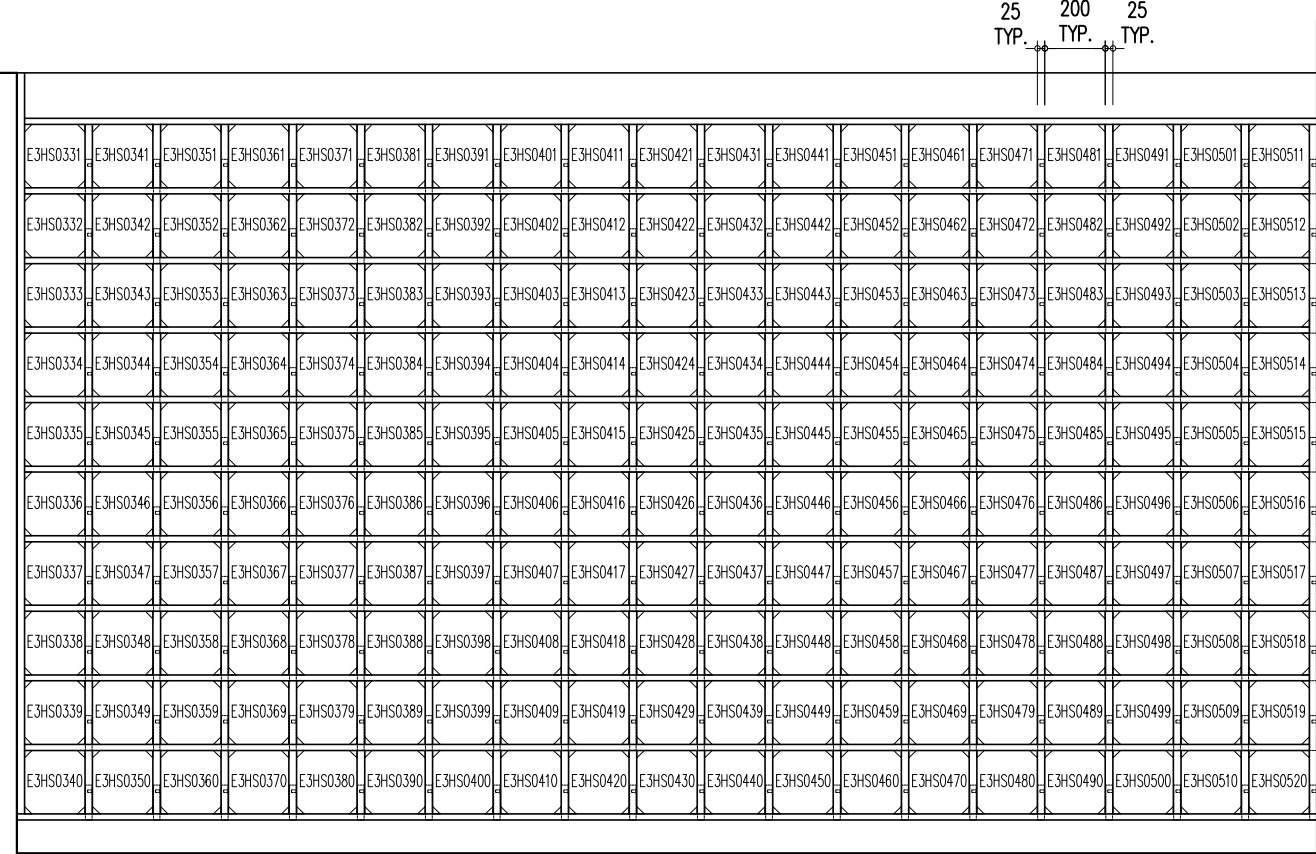

E3HS0331 ~ E3HS0520  
3/F ELEVATION B

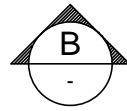
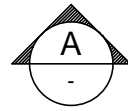
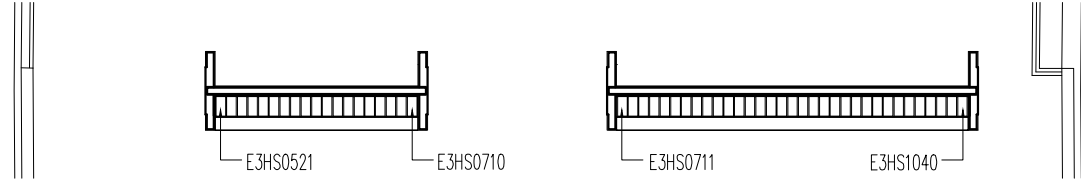

3/F FLOOR PLAN

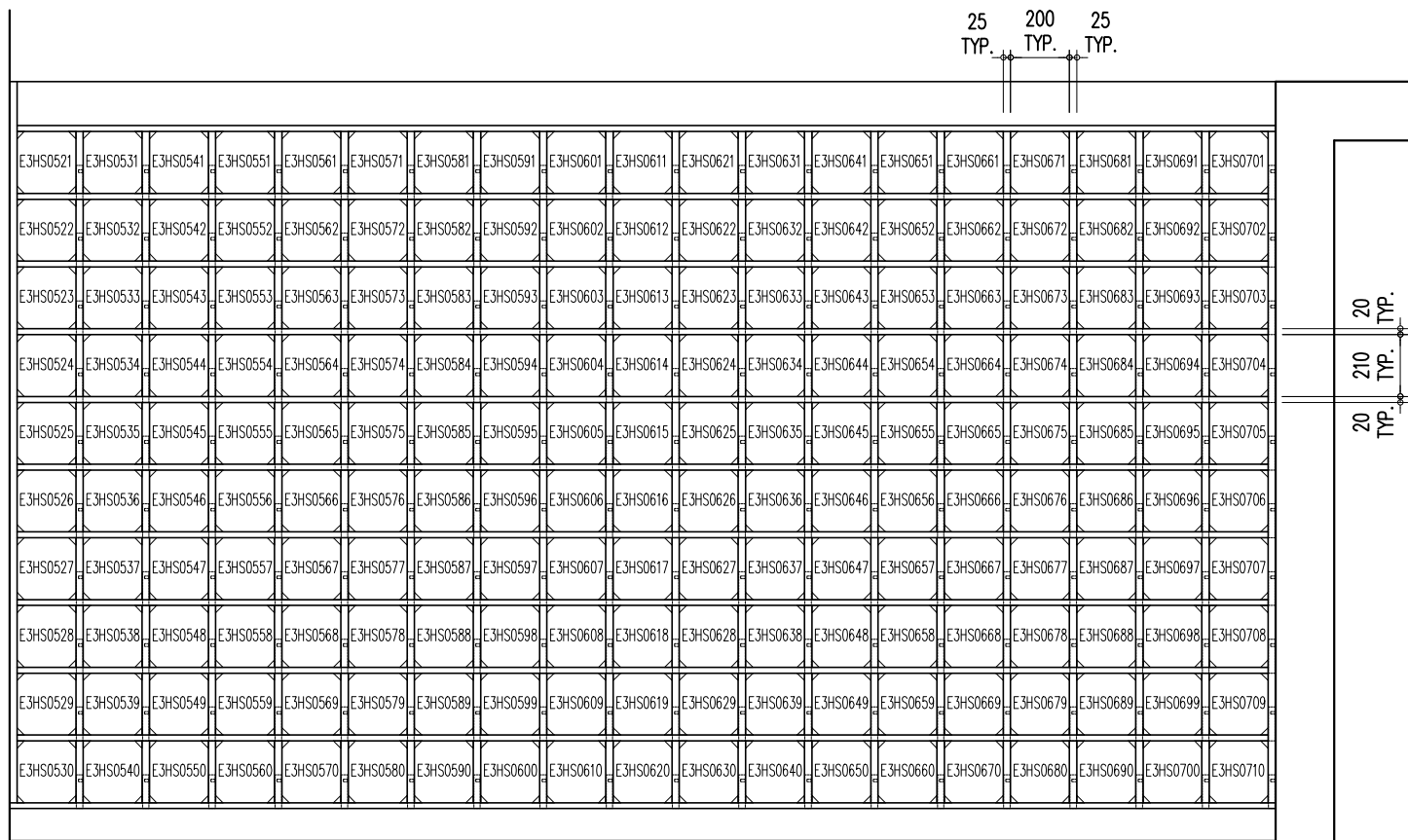

FLOOR LEVEL

E3HS0521 ~ E3HS0710  
3/F ELEVATION A

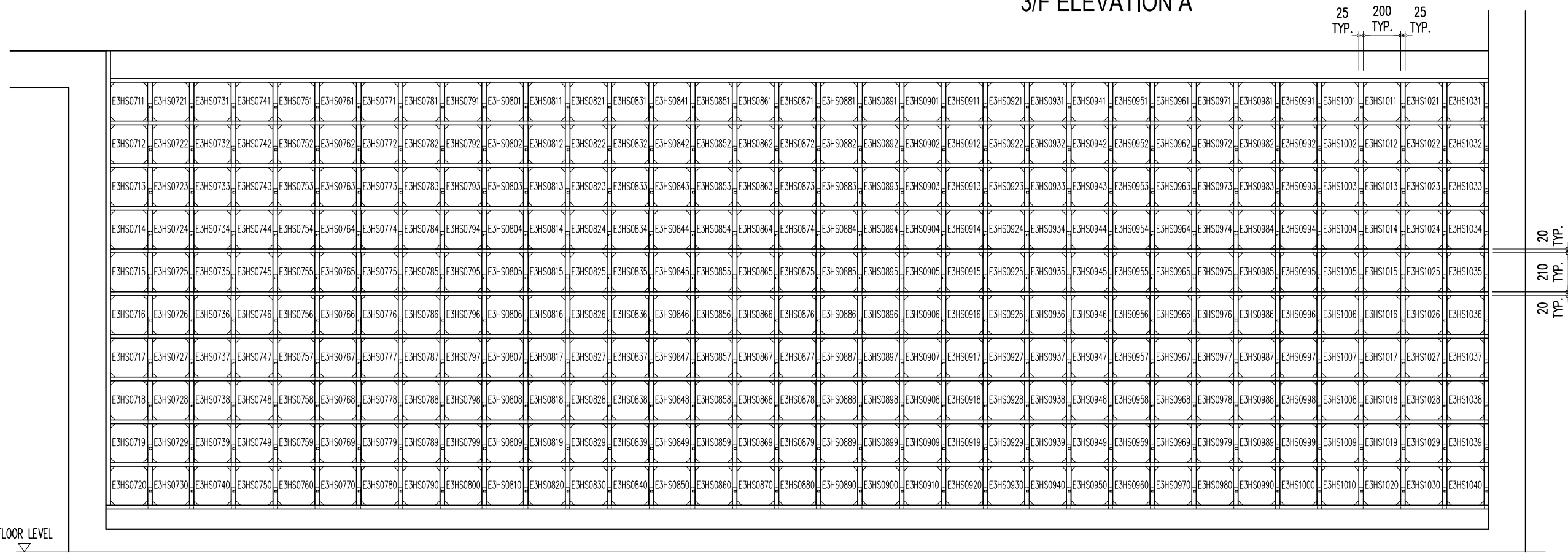

FLOOR LEVEL

E3HS0711 ~ E3HS1040  
3/F ELEVATION B



25  
TYP.    200  
TYP.    25  
TYP.

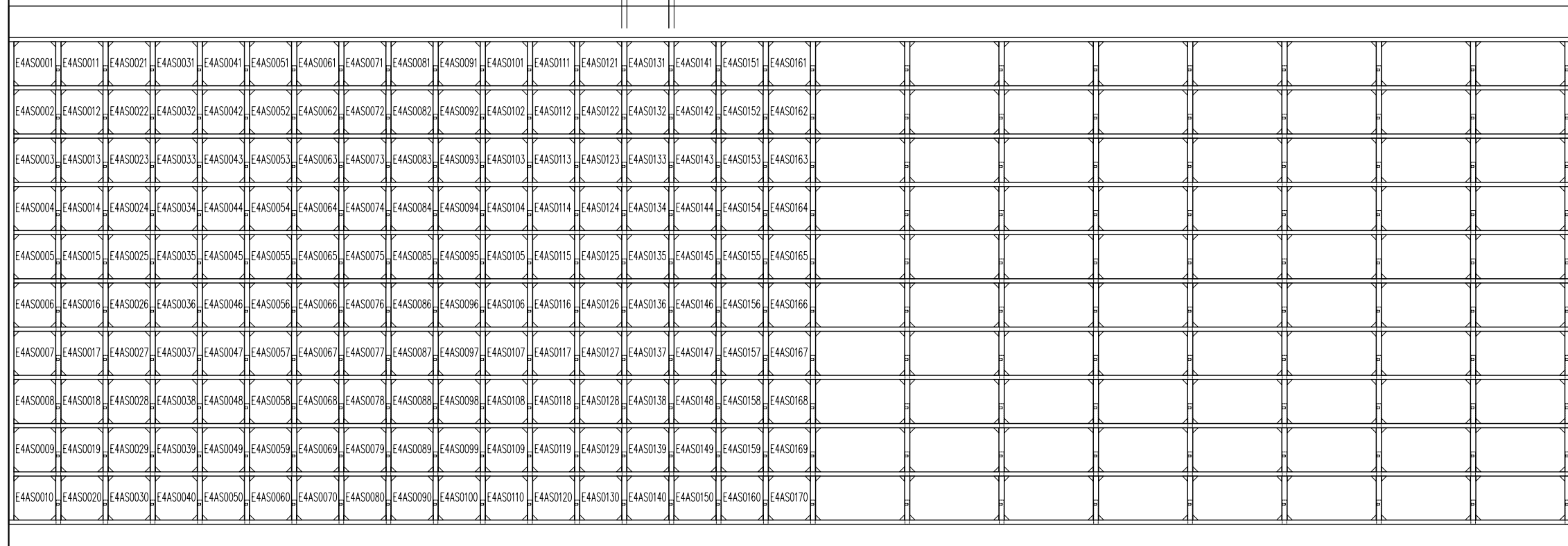

FLOOR LEVEL

E4AS0001 ~ E4AS0170  
4/F ELEVATION A

25  
TYP.    200  
TYP.    25  
TYP.

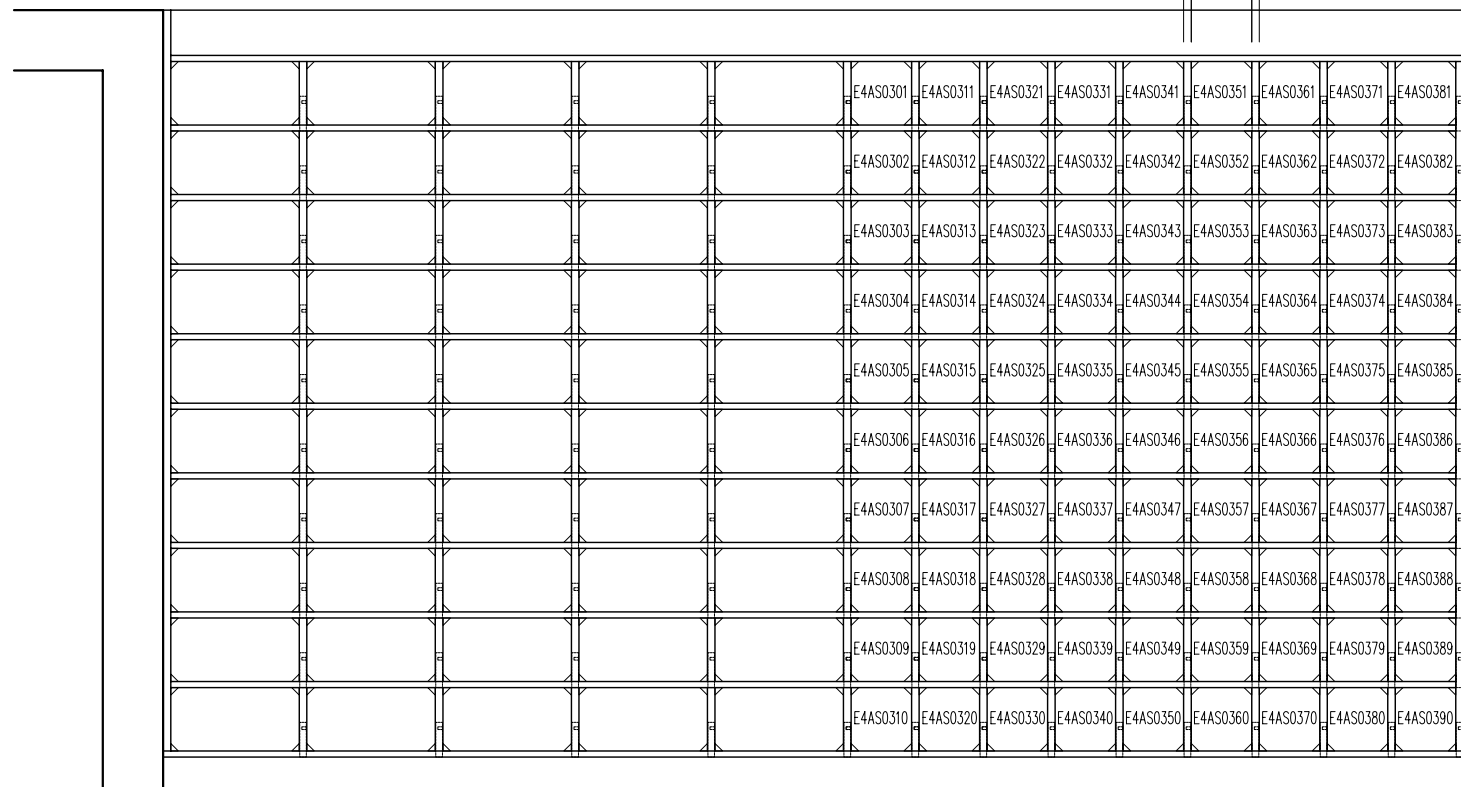

FLOOR LEVEL

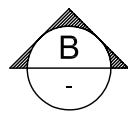
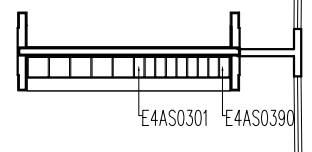
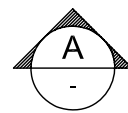
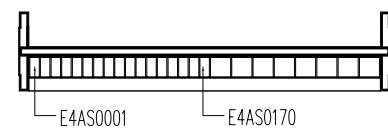
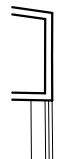

4/F FLOOR PLAN

E4AS0301 ~ E4AS0390  
4/F ELEVATION B

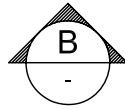
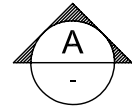
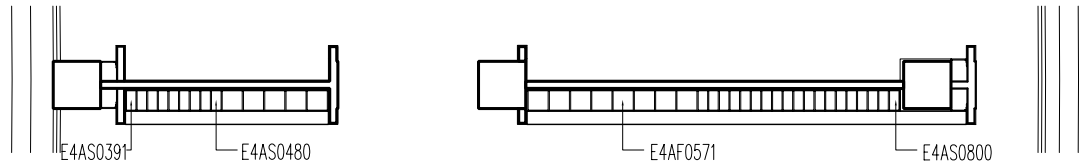

4/F FLOOR PLAN

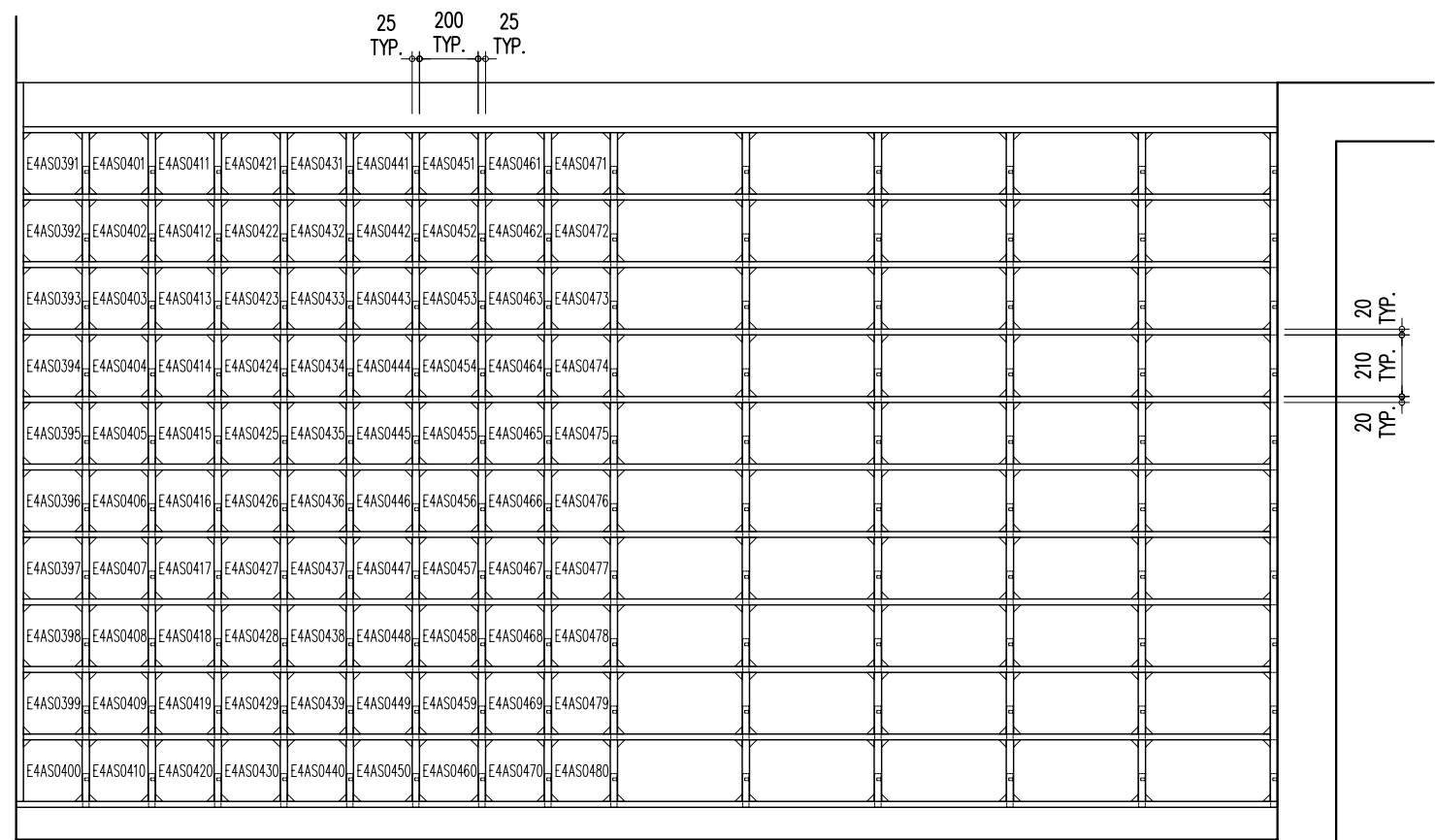

FLOOR LEVEL

E4AS0391 ~ E4AS0480  
4/F ELEVATION A

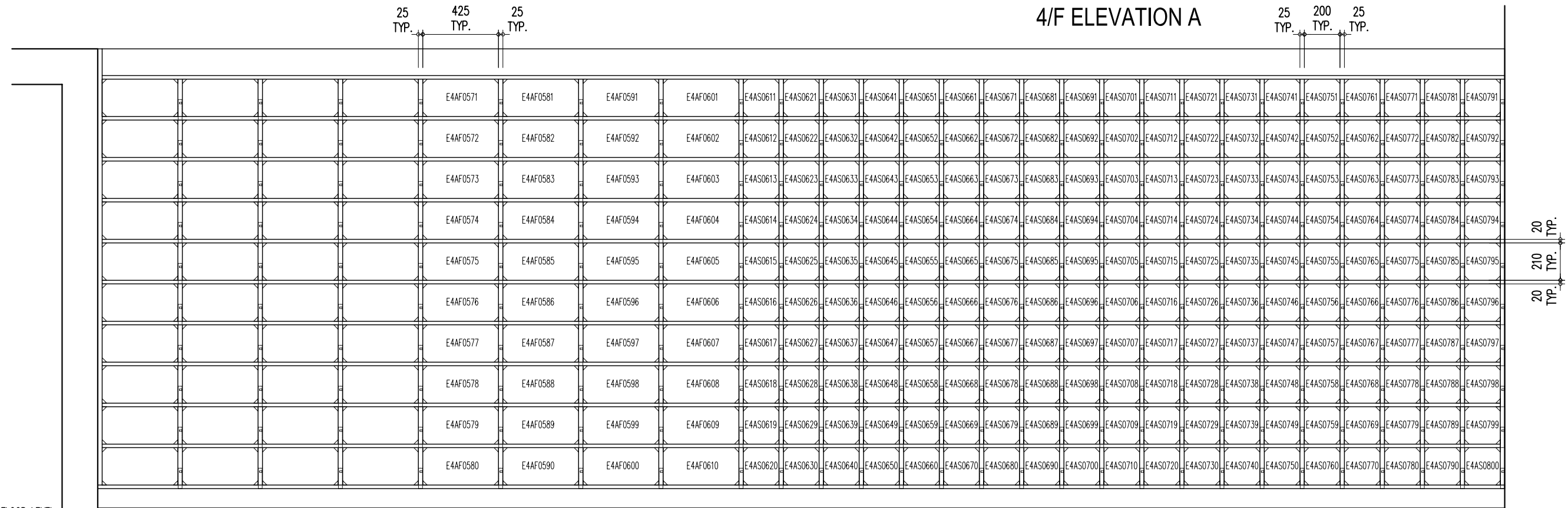

FLOOR LEVEL

E4AF0571 ~ E4AF0610 E4AS0611 ~ E4AS0800  
4/F ELEVATION B

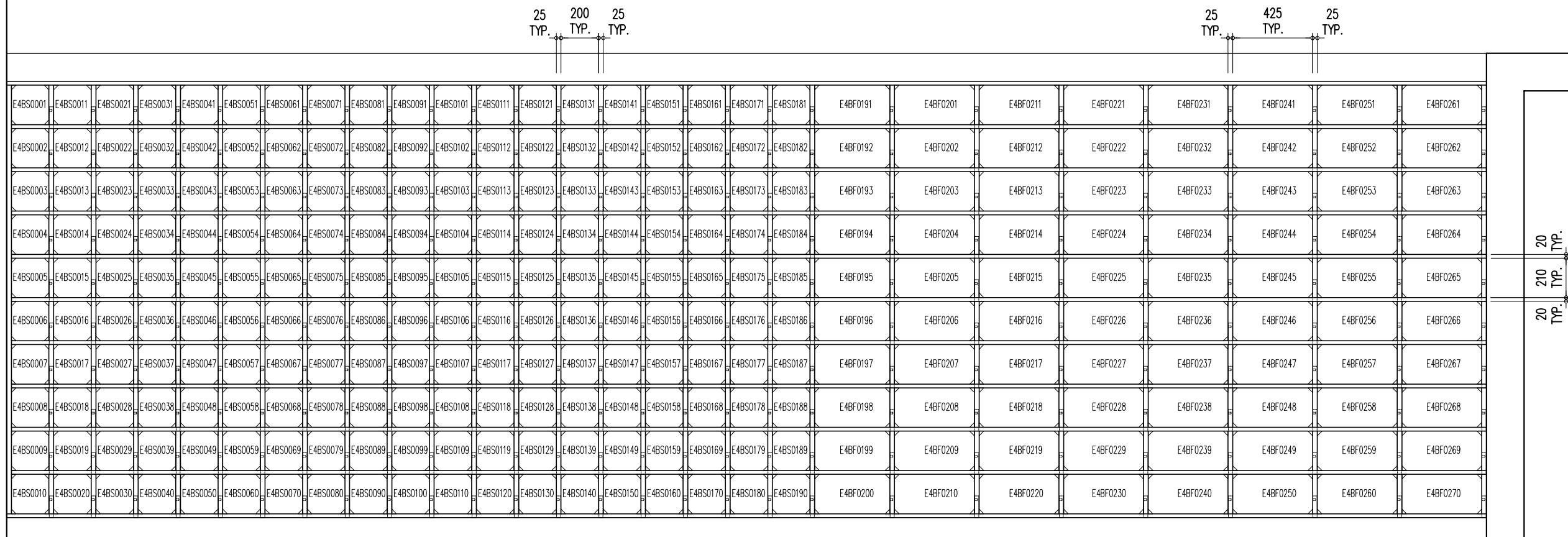

FLOOR LEVEL

E4BS0001 ~ E4BS0190 E4BF0191 ~ E4BF0270  
4/F ELEVATION A

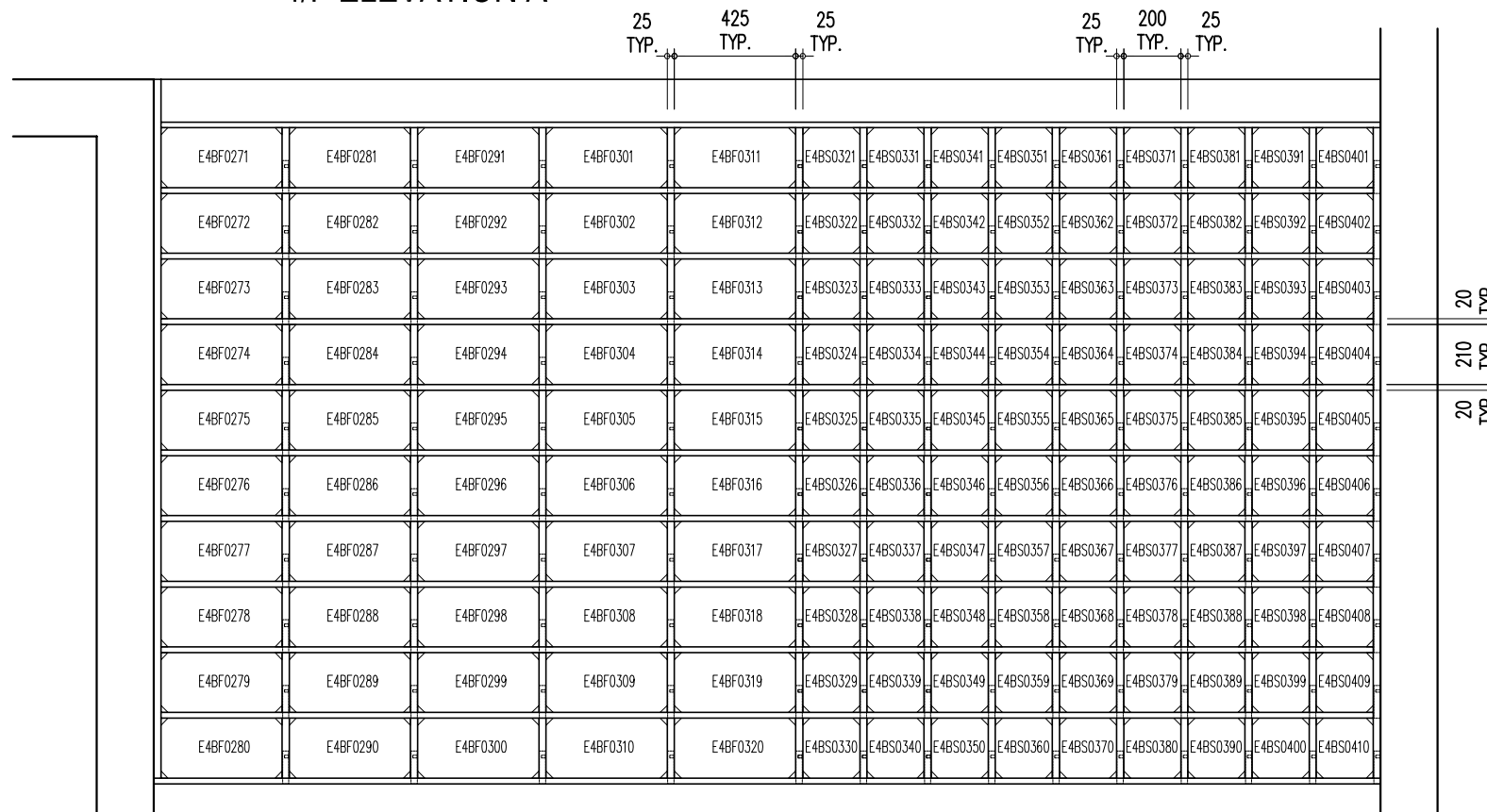

FLOOR LEVEL

E4BF0271 ~ E4BF0320 E4BS0321 ~ E4BS0410  
4/F ELEVATION B

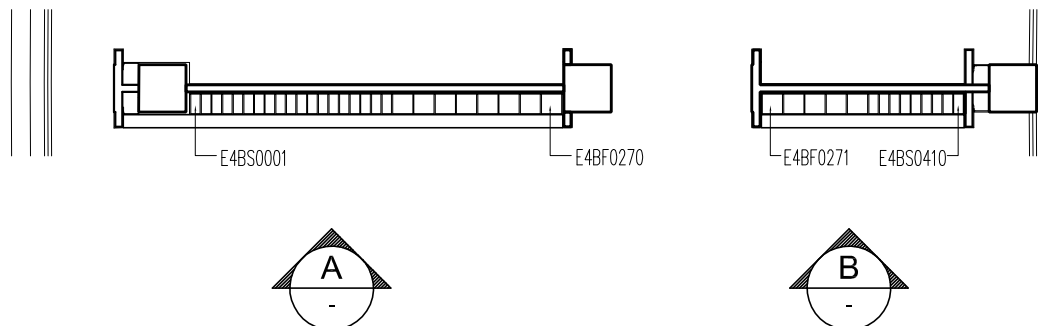

4/F FLOOR PLAN

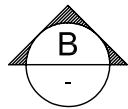
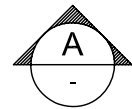
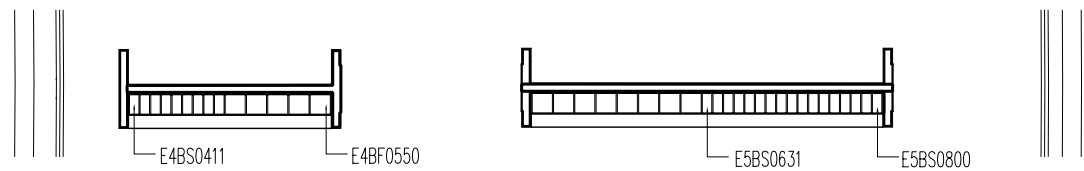

4/F FLOOR PLAN

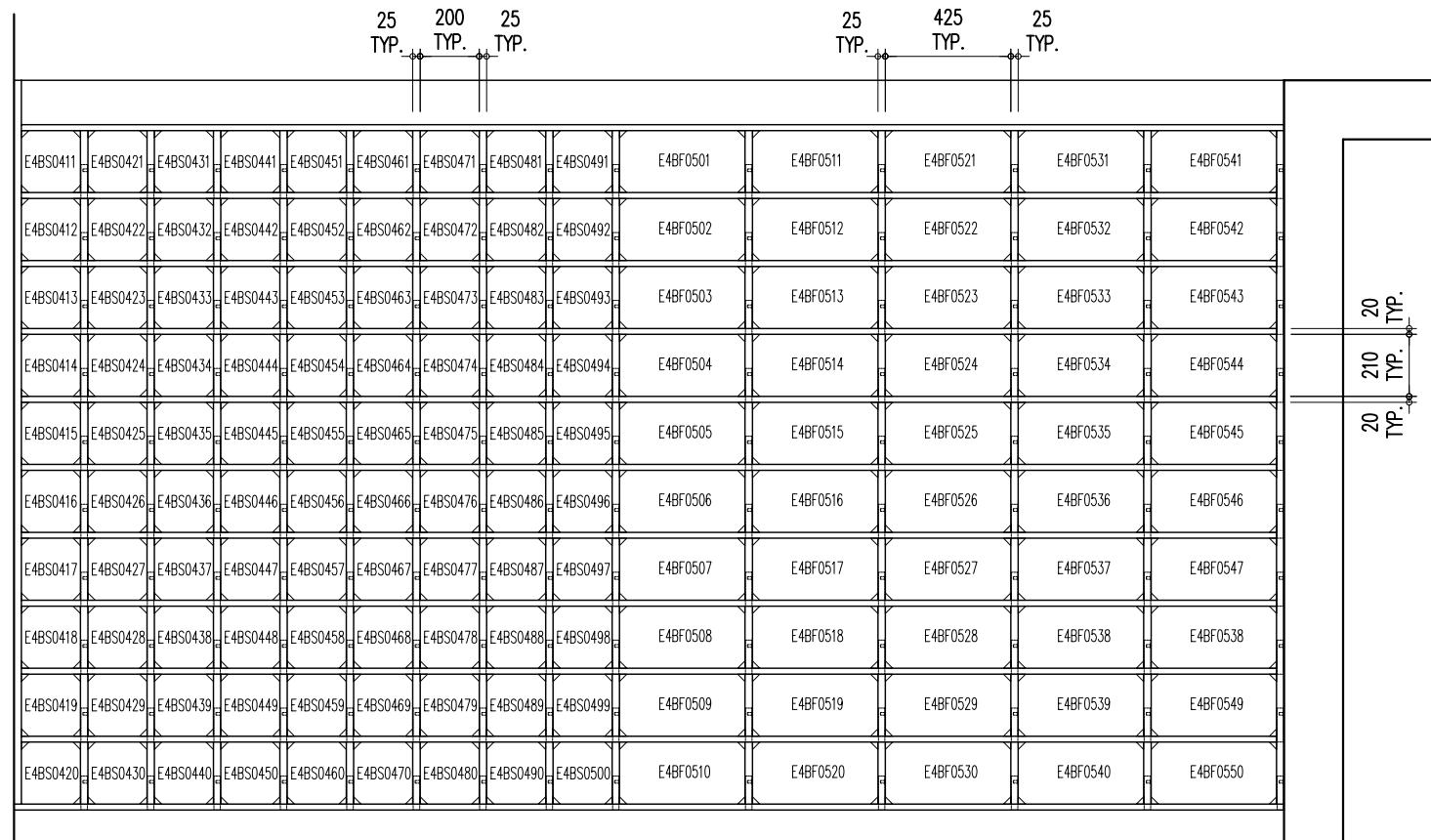

FLOOR LEVEL

E4BS0411 ~ E4BS0500 E4BF0501 ~ E4BF0550

4/F ELEVATION A

25 TYP. 200 TYP. 25 TYP.

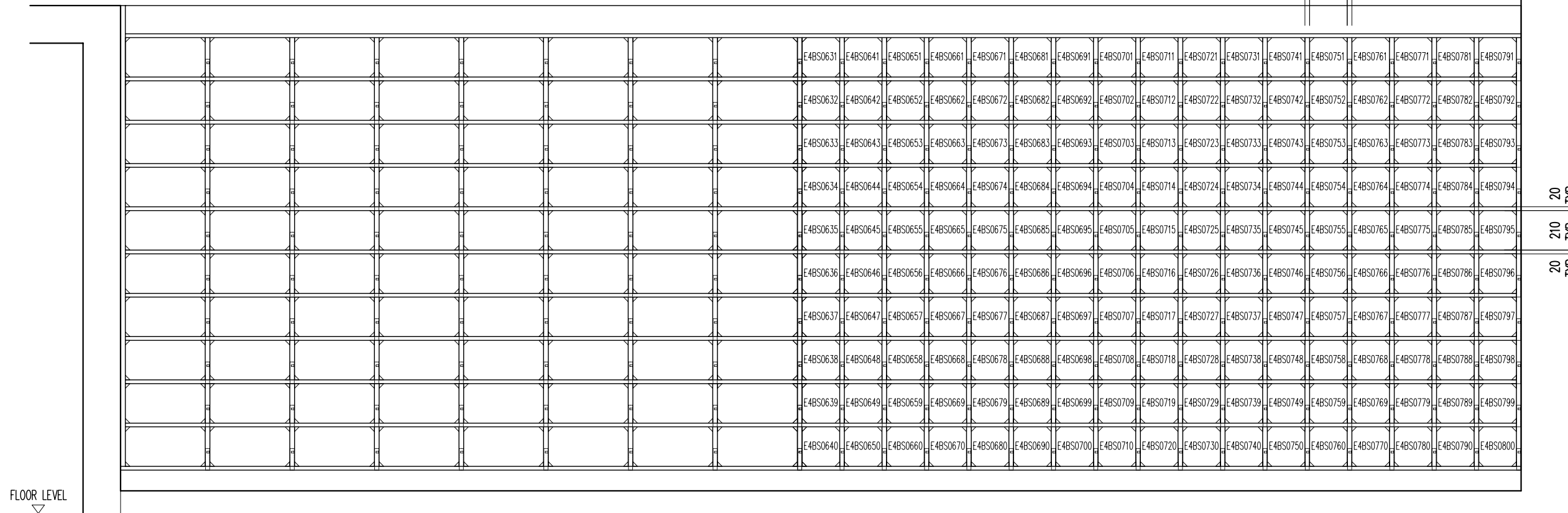

FLOOR LEVEL

E4BS0631 ~ E4BS0800  
4/F ELEVATION B

25 TYP. 200 TYP. 25 TYP.

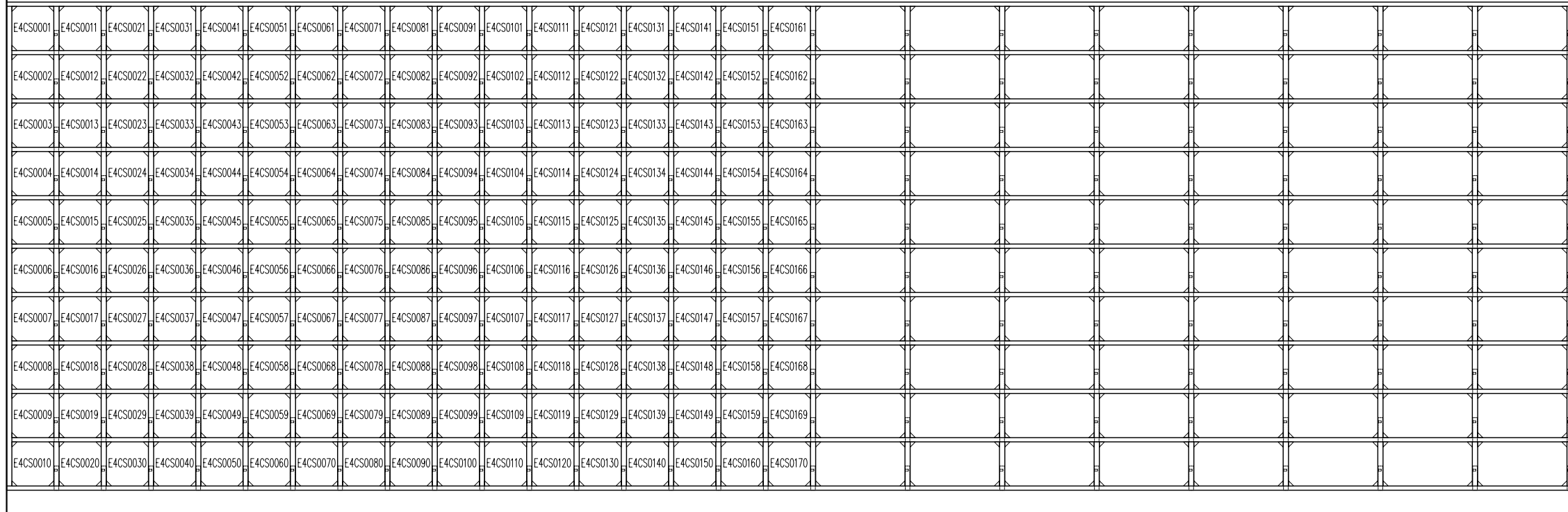

20 TYP. 210 TYP. 20 TYP.

FLOOR LEVEL

E4CS0001 ~ E4CS0170  
4/F ELEVATION A

25 TYP. 200 TYP. 25 TYP.

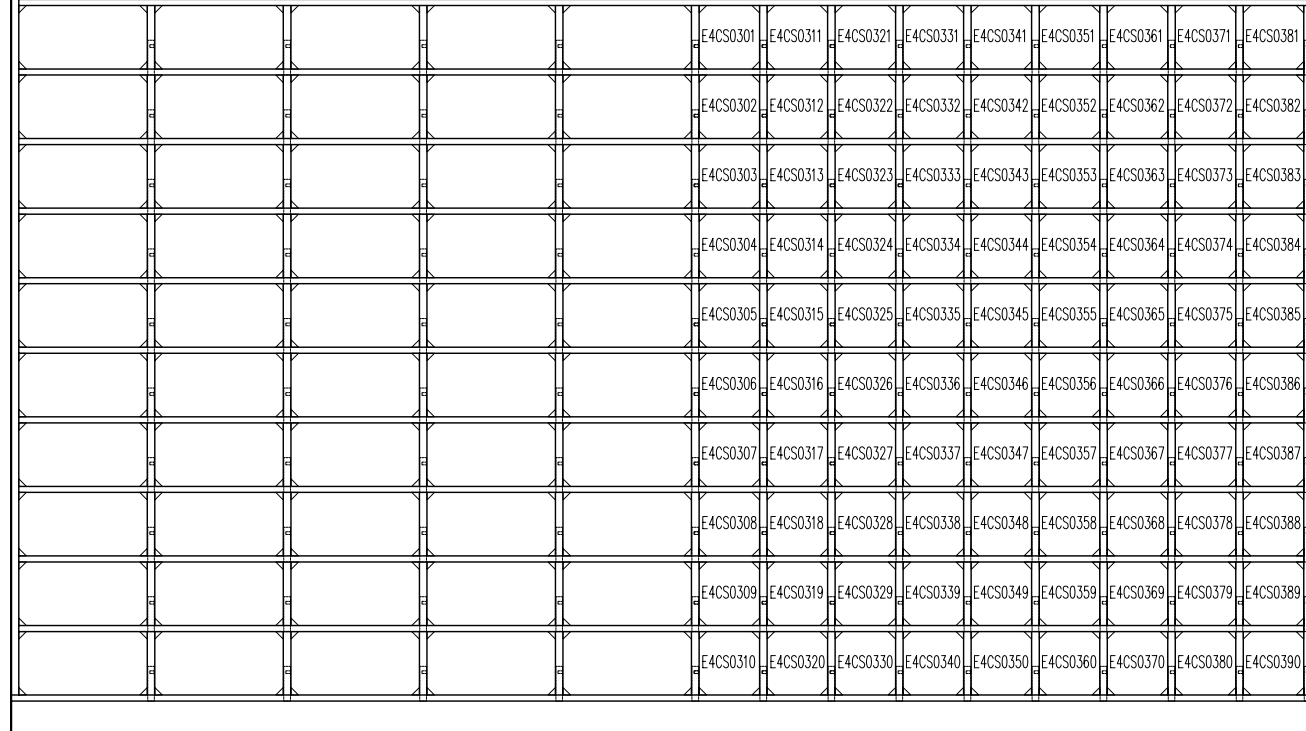

20 TYP. 210 TYP. 20 TYP.

FLOOR LEVEL

E4CS0301 ~ E4CS0390  
4/F ELEVATION B

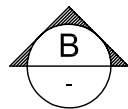
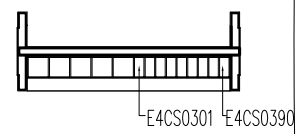
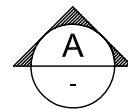
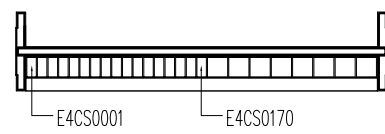

4/F FLOOR PLAN



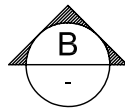
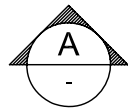
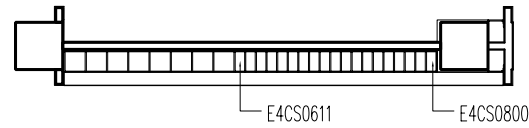
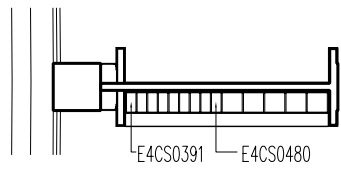

4/F FLOOR PLAN

FLOOR LEVEL

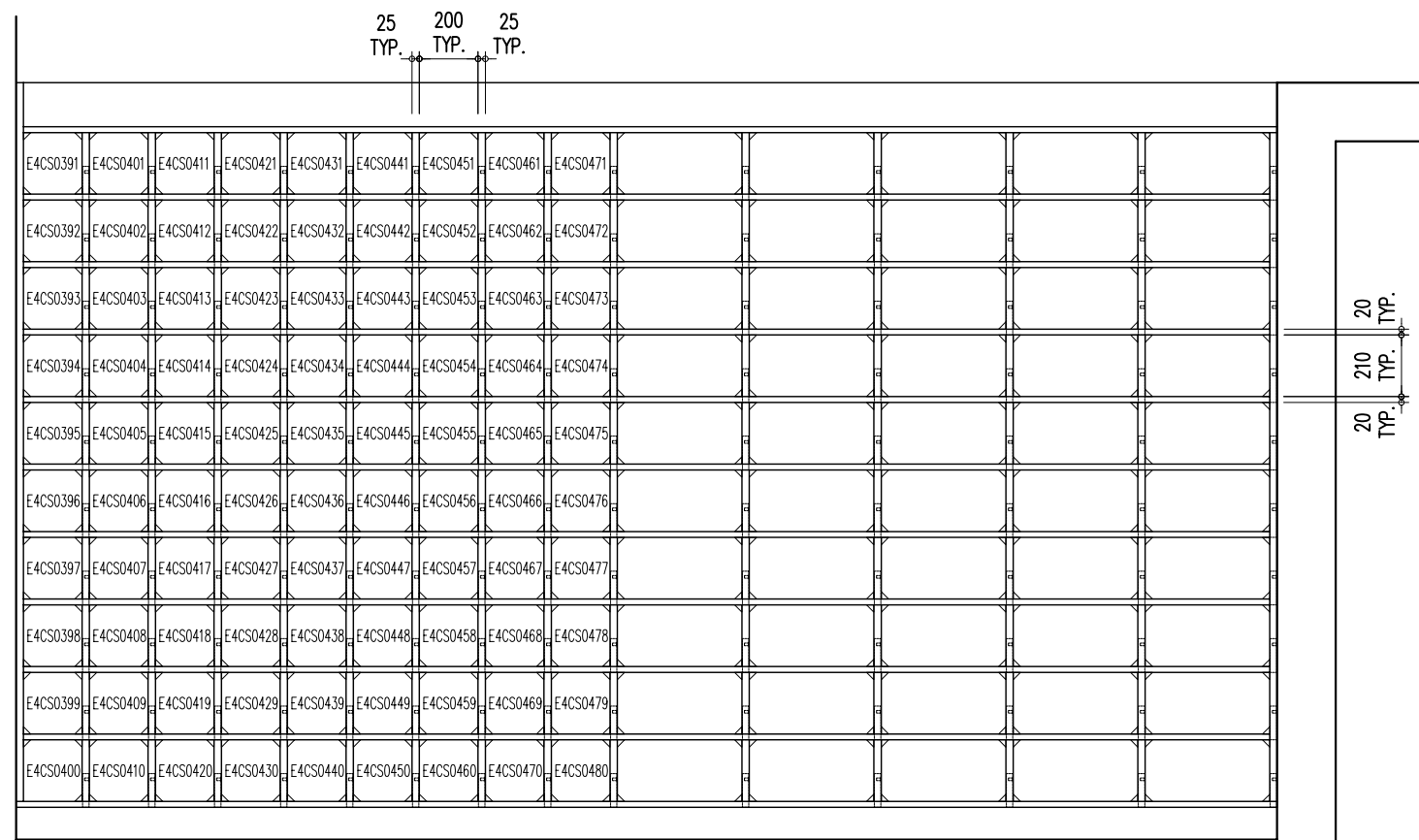

E4CS0391 ~ E4CS0480  
4/F ELEVATION A

25 TYP. 200 TYP. 25 TYP.

20 TYP. 210 TYP. 20 TYP.

FLOOR LEVEL

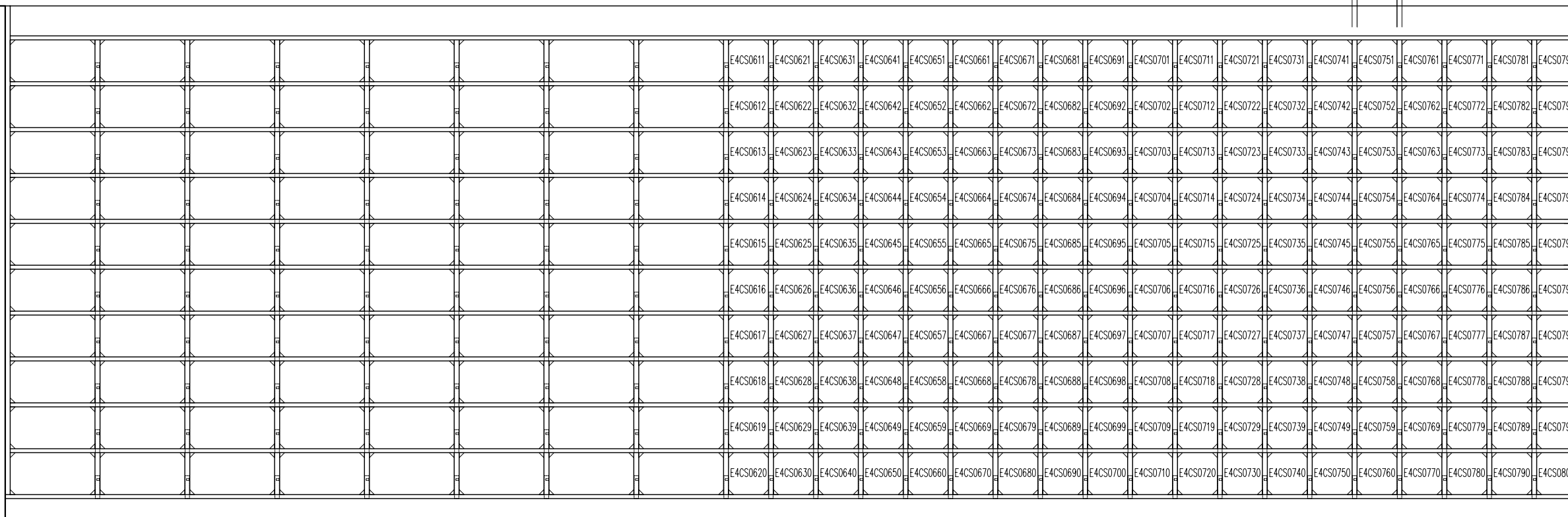

E4CS0611 ~ E4CS0800  
4/F ELEVATION B

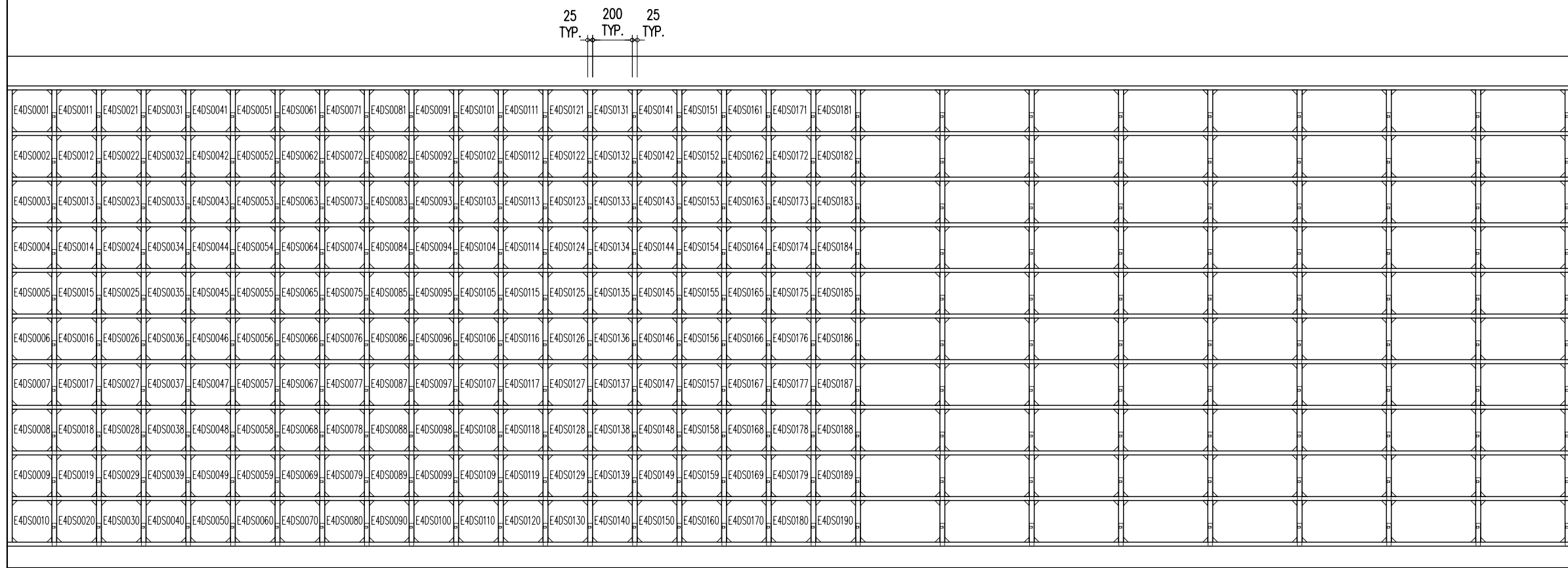

FLOOR LEVEL

E4DS0001 ~ E4DS0190  
4/F ELEVATION A

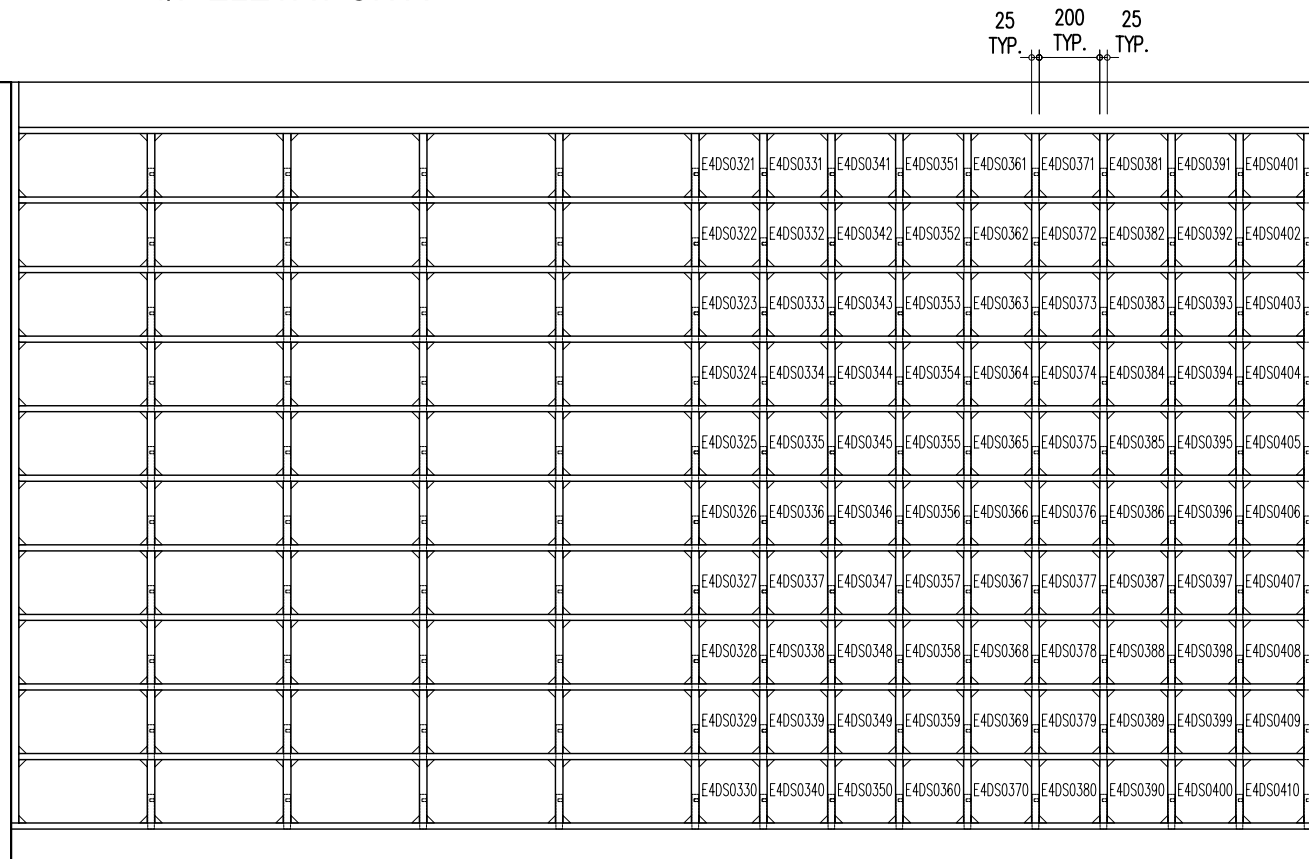

FLOOR LEVEL

E4DS0321 ~ E4DS0410  
4/F ELEVATION B

4/F FLOOR PLAN

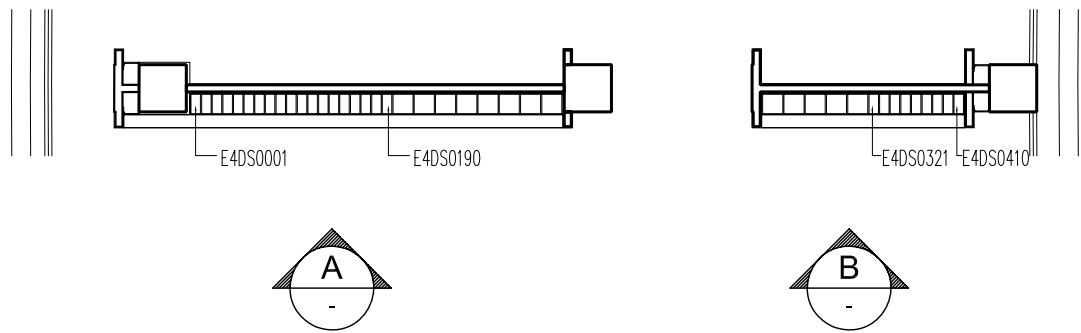

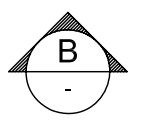
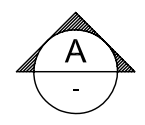
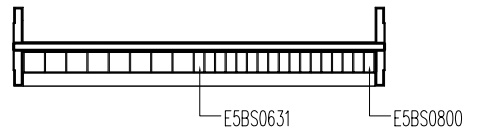
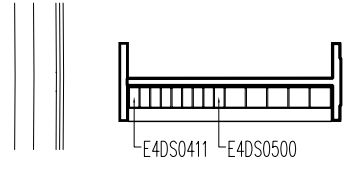

4/F FLOOR PLAN

FLOOR LEVEL

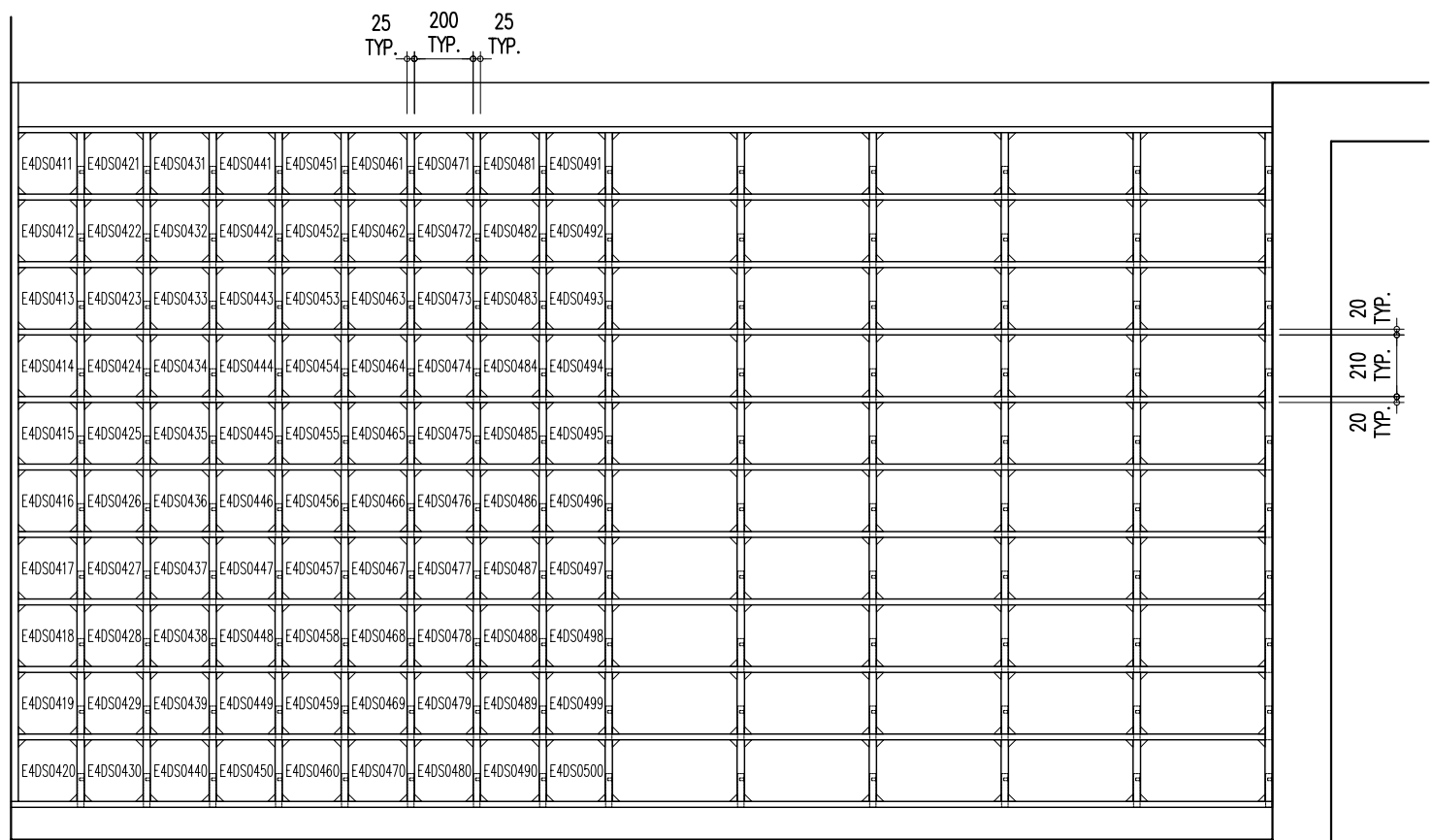

E4DS0411 ~ E4DS0500  
4/F ELEVATION A

25 TYP. 200 TYP. 25 TYP.

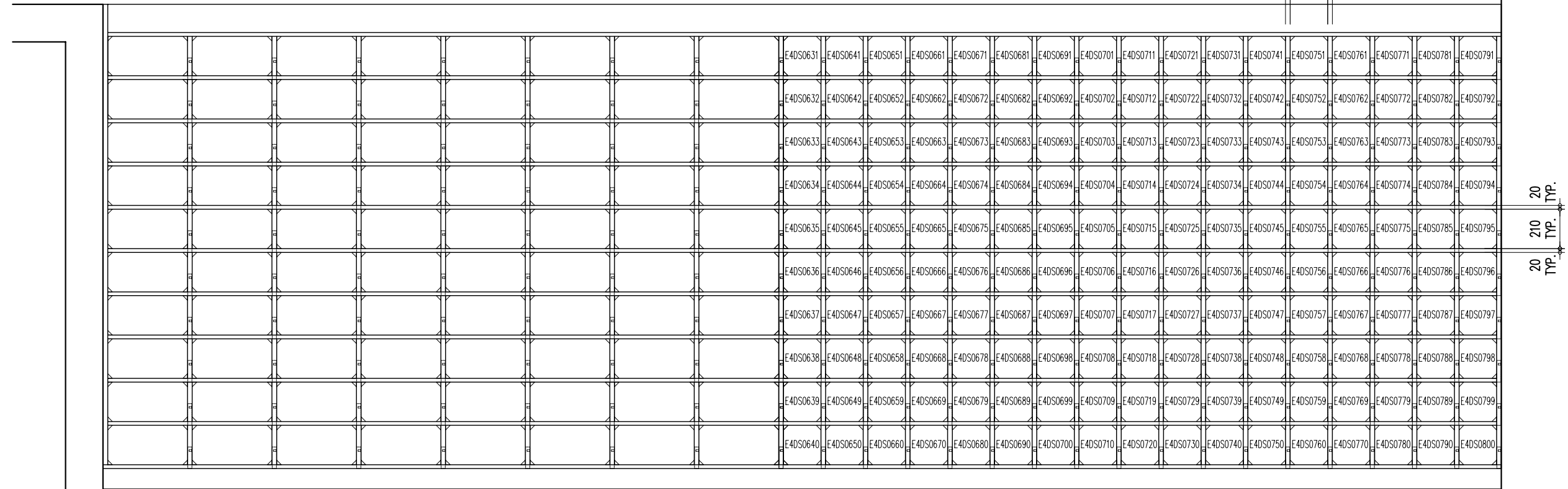

FLOOR LEVEL

E4DS0631 ~ E4DS0800  
4/F ELEVATION B



25  
TYP.    200  
TYP.    25  
TYP.

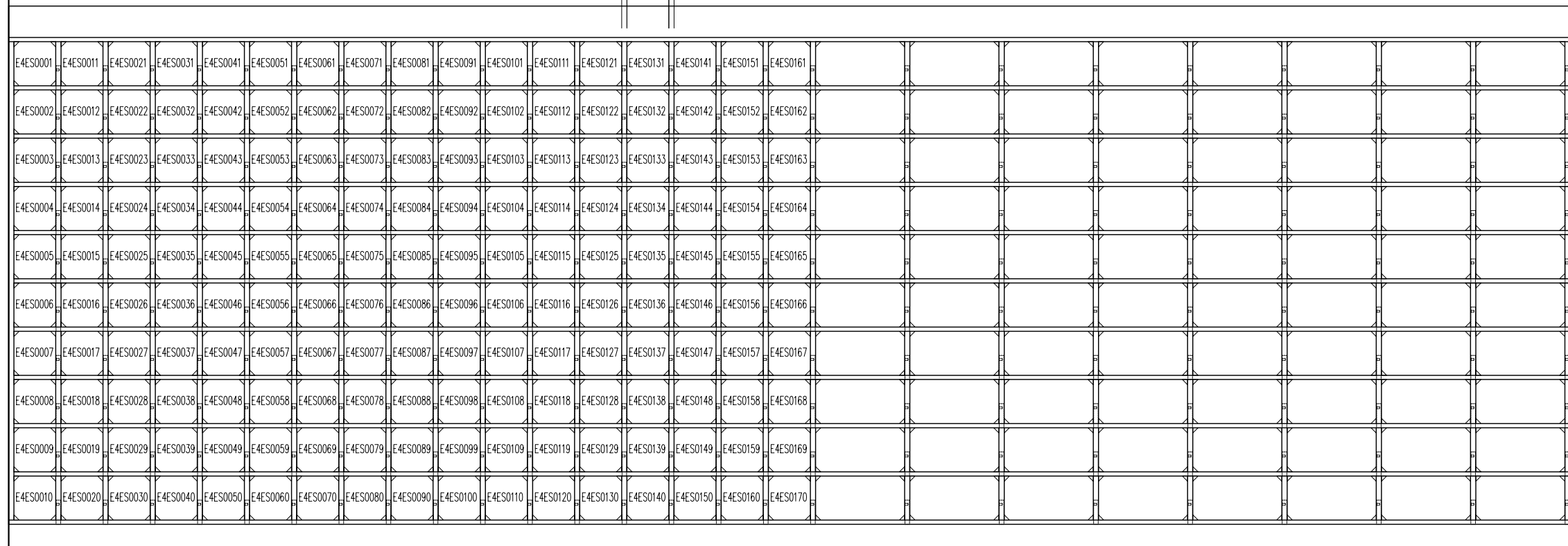

FLOOR LEVEL

E4ES0001 ~ E4ES0170  
4/F ELEVATION A

25  
TYP.    200  
TYP.    25  
TYP.

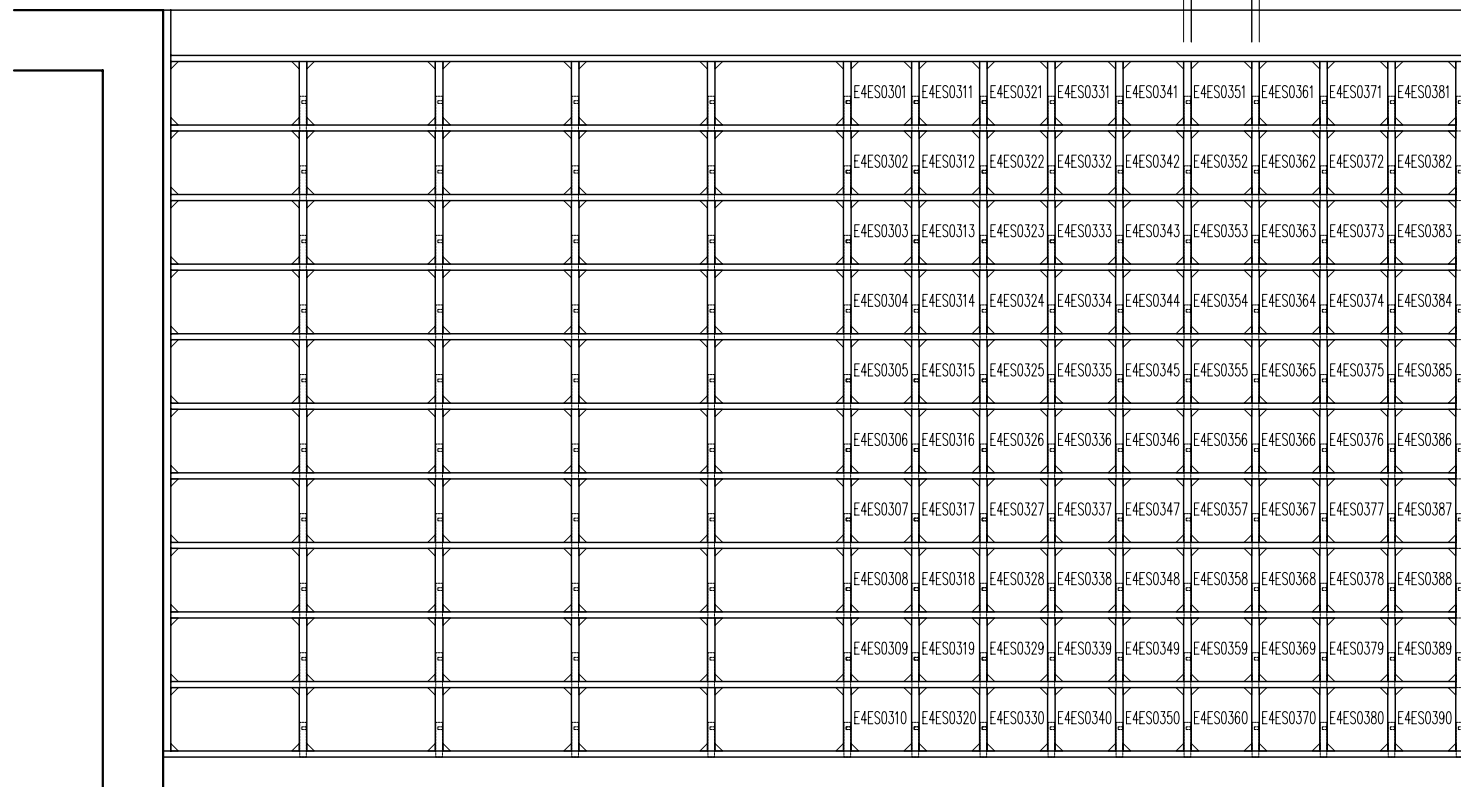

FLOOR LEVEL

E4ES0301 ~ E4ES0390  
4/F ELEVATION B

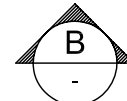
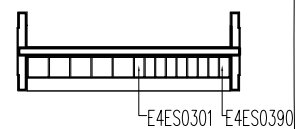
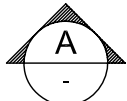
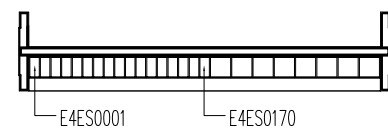

4/F FLOOR PLAN



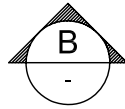
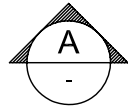
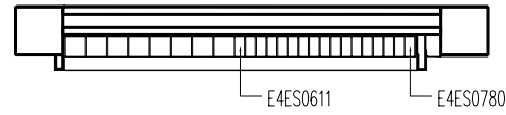
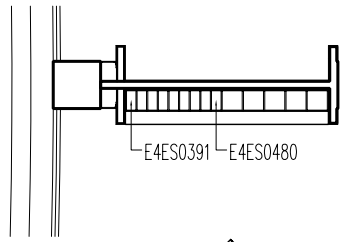

8/F FLOOR PLAN

FLOOR LEVEL

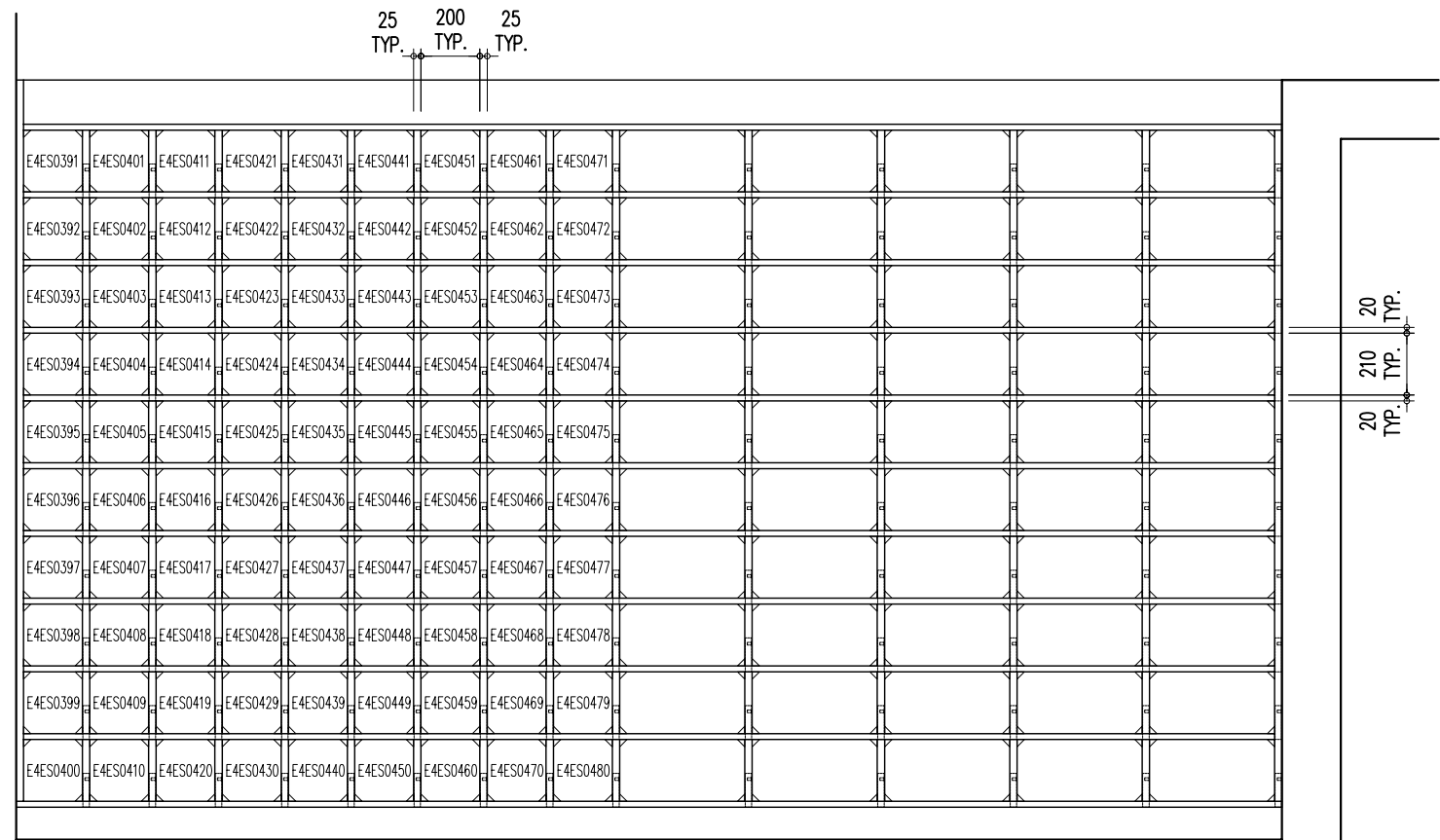

E4ES0391 ~ E4ES0480  
4/F ELEVATION A

25 TYP. 200 TYP. 25 TYP.

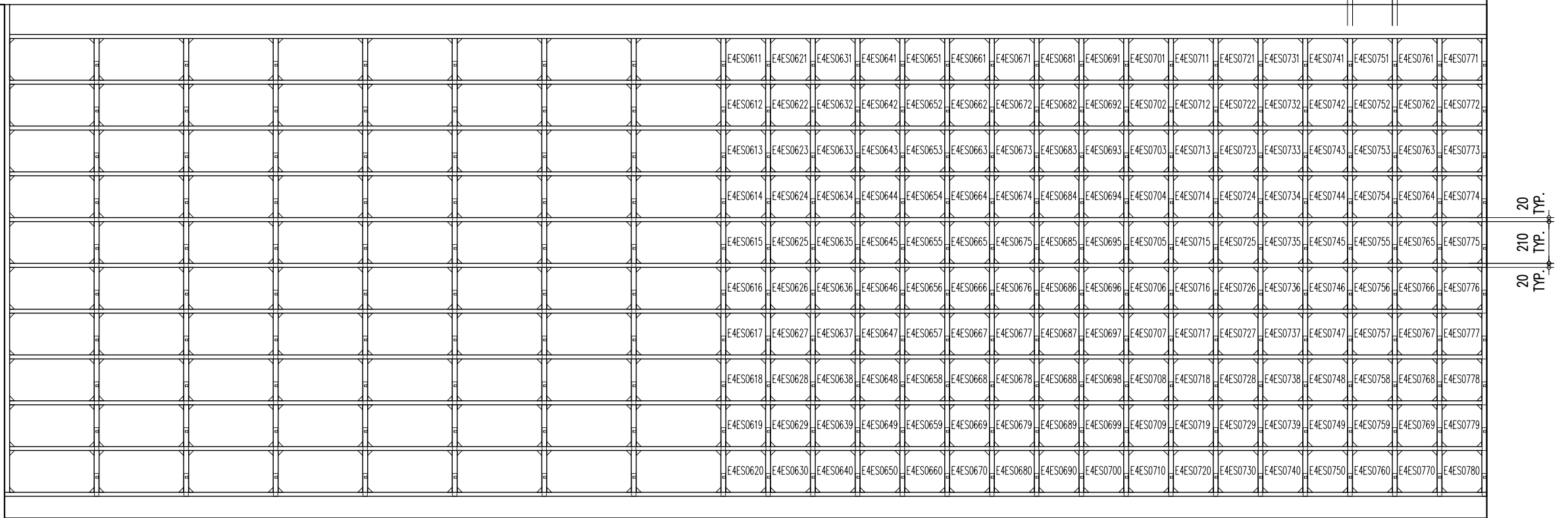

FLOOR LEVEL

E4ES0611 ~ E4ES0780  
4/F ELEVATION B

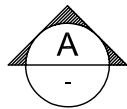
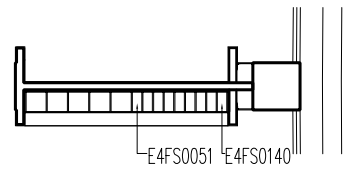

4/F FLOOR PLAN

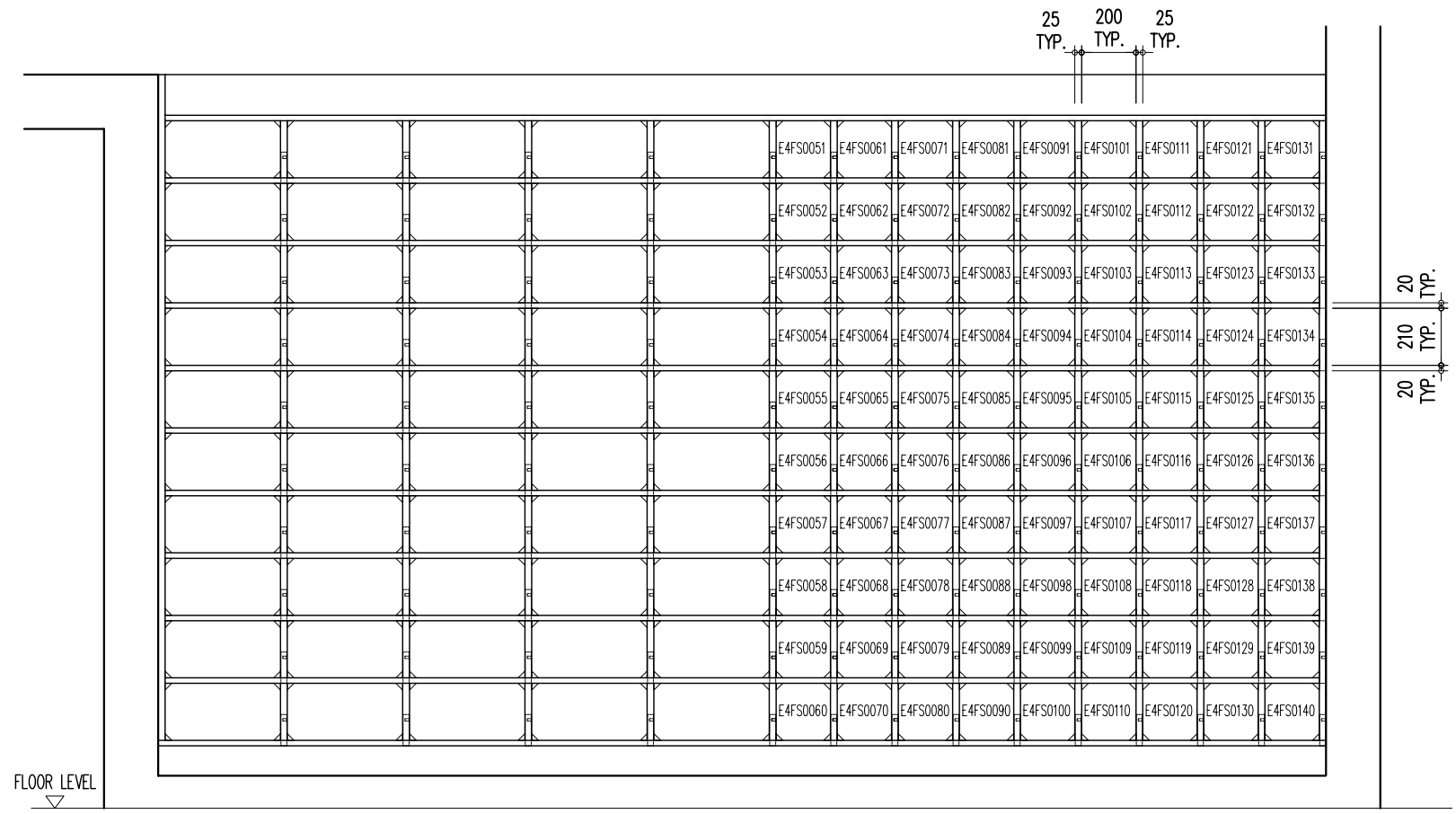

E4FS0051 ~ E4FS0140  
4/F ELEVATION A

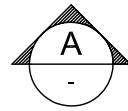
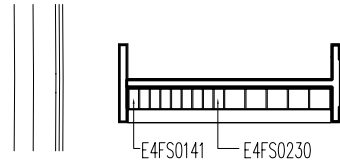

4/F FLOOR PLAN

FLOOR LEVEL  
▽

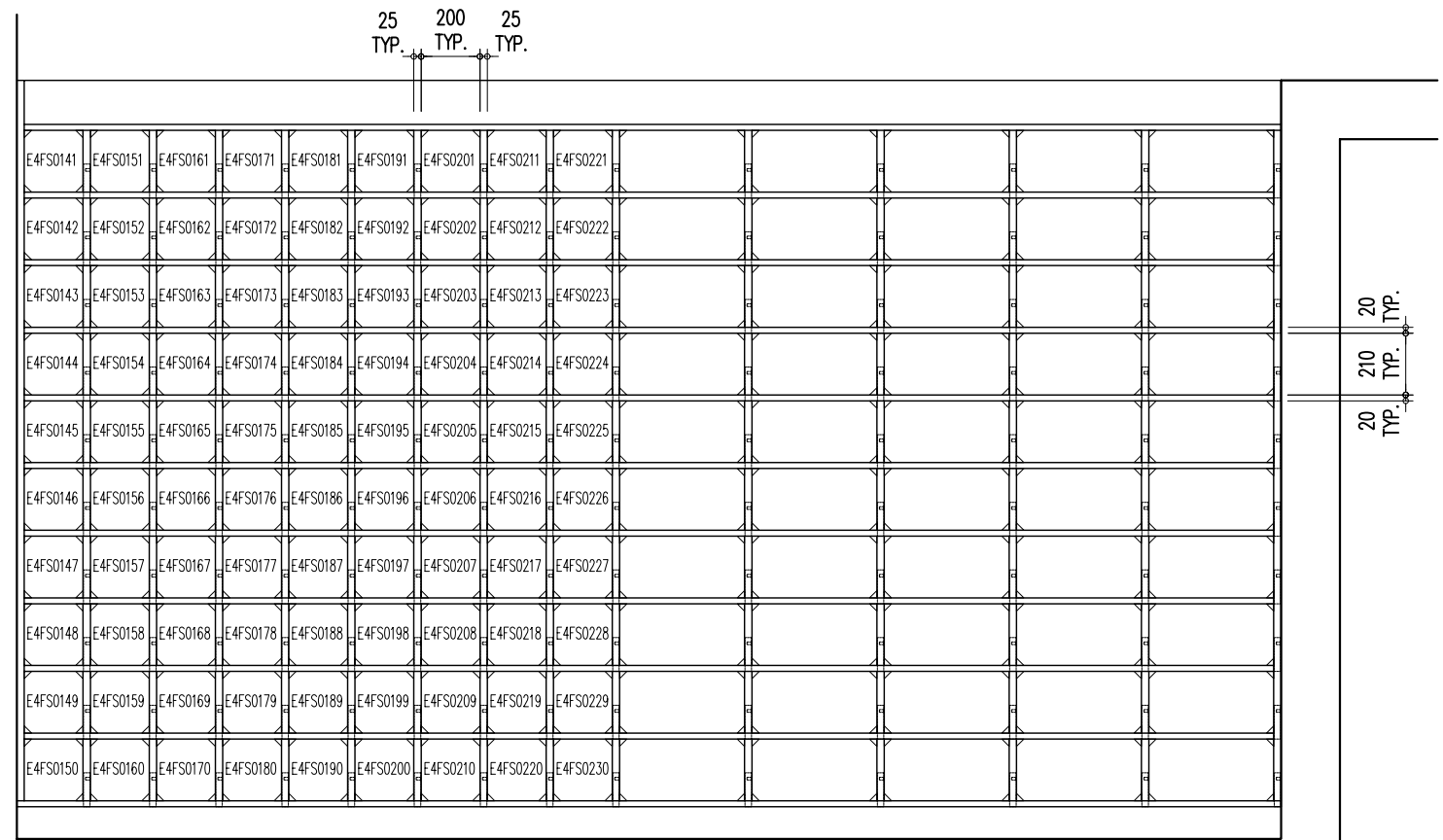

E4FS0141 ~ E4FS0230  
4/F ELEVATION A

4/F FLOOR PLAN

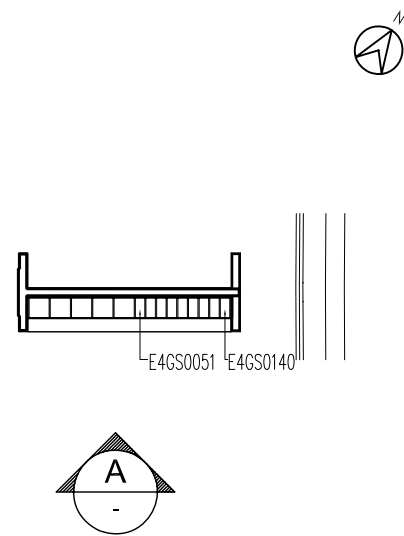

FLOOR LEVEL  
▽

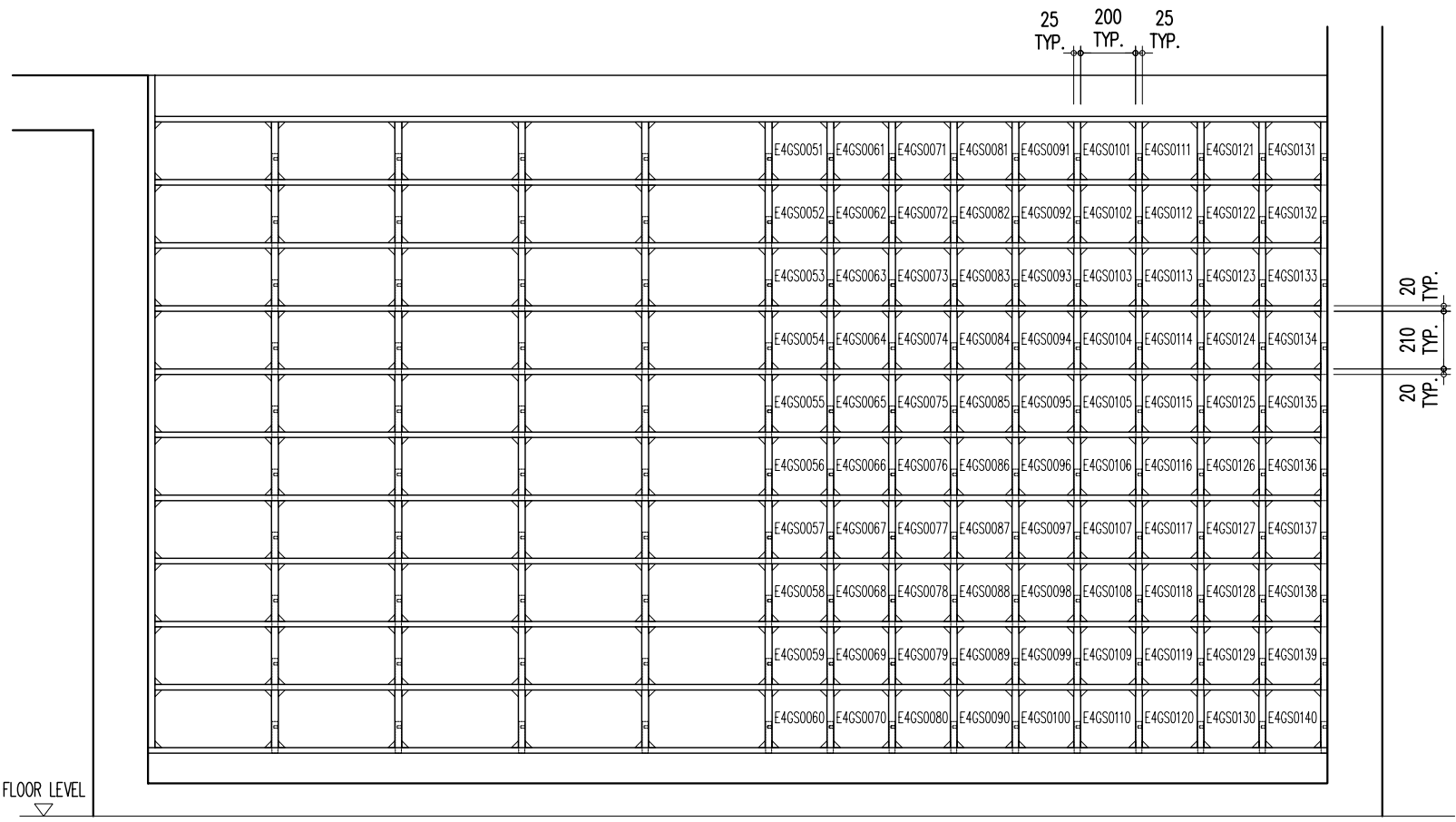

E4GS0051 ~ E4GS0140  
4/F ELEVATION A

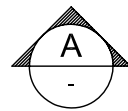
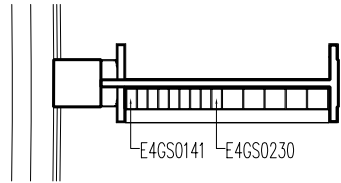

4/F FLOOR PLAN

FLOOR LEVEL

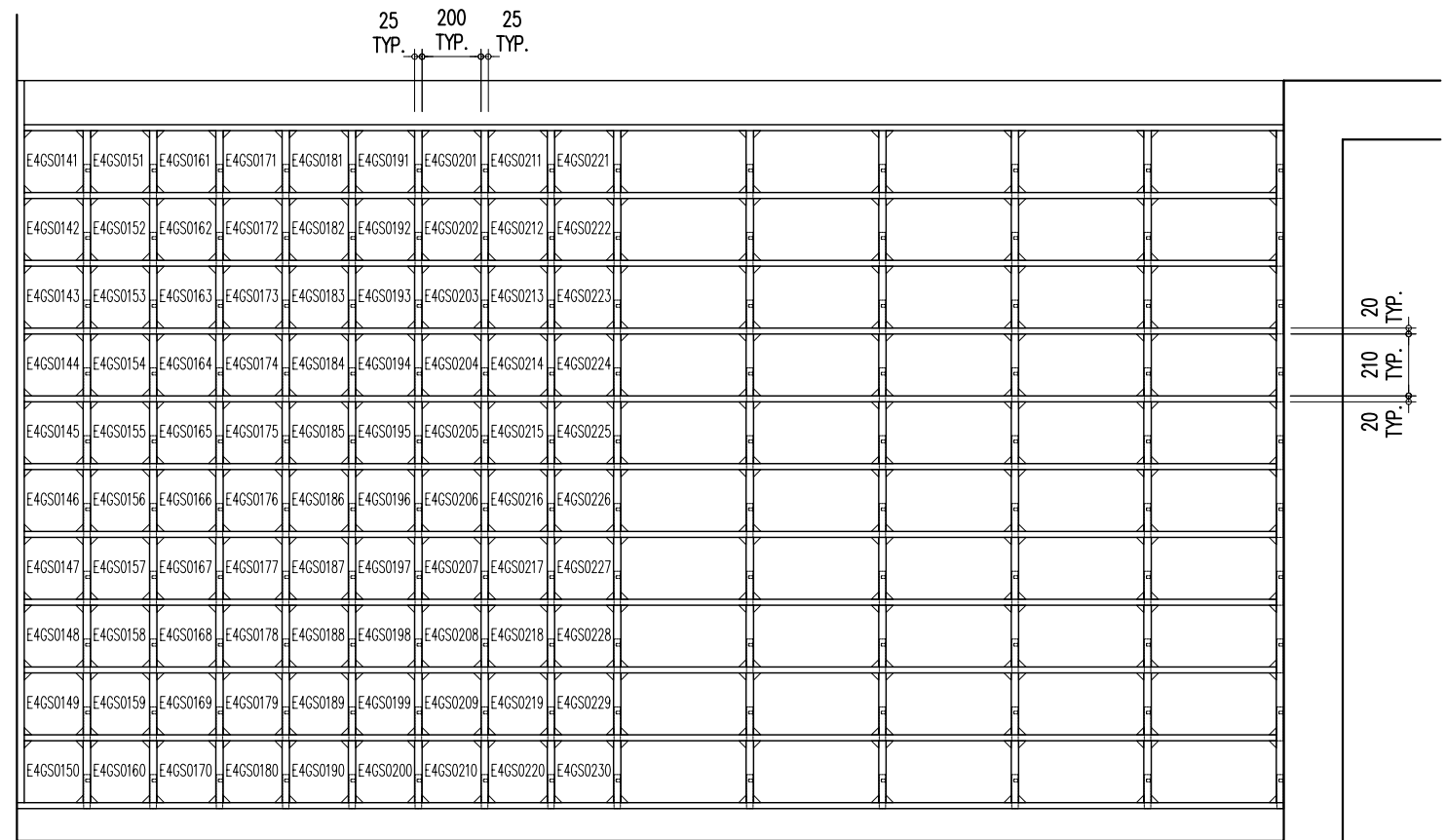

E4GS0141 ~ E4GS0230  
4/F ELEVATION A

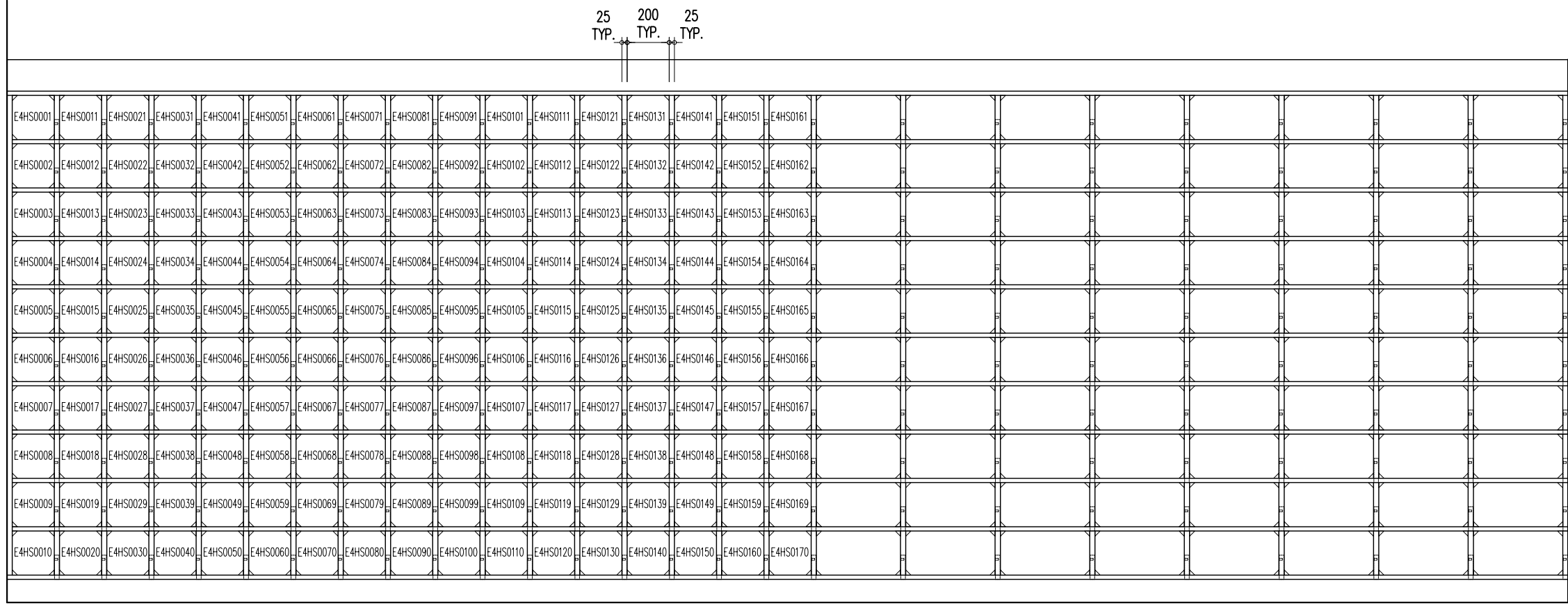

E4HS0001 ~ E4HS0170  
4/F ELEVATION A

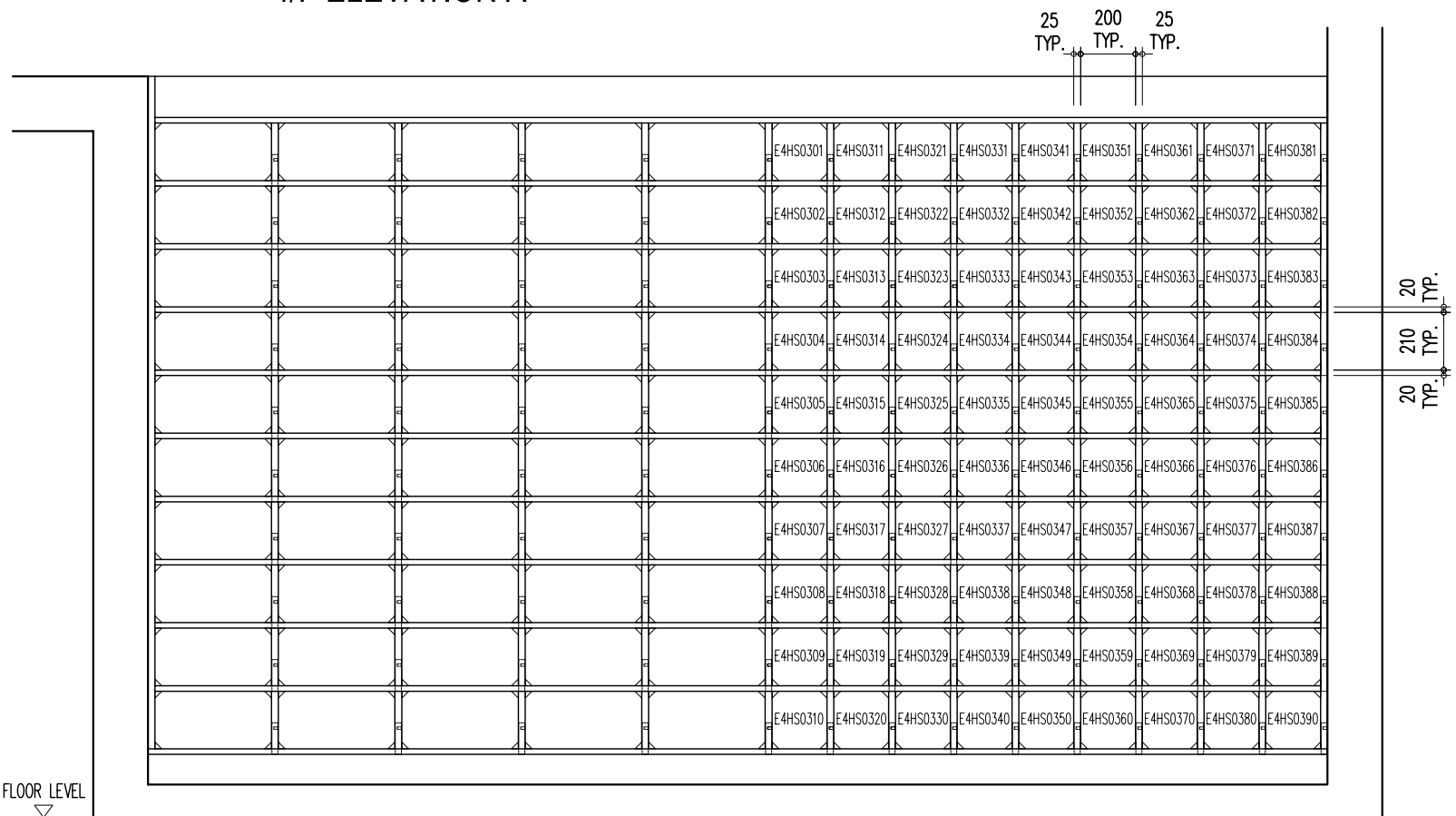

E4HS0301 ~ E4HS0390  
4/F ELEVATION B

FLOOR LEVEL

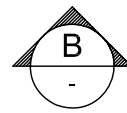
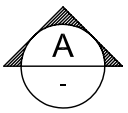
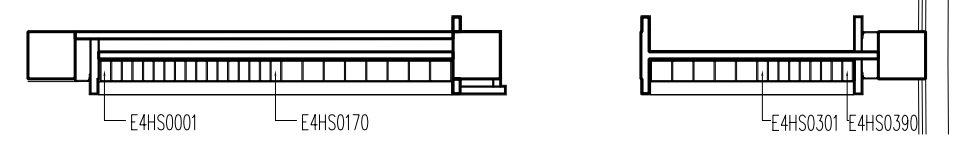

4/F FLOOR PLAN



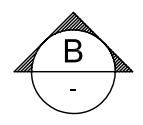
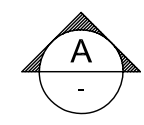
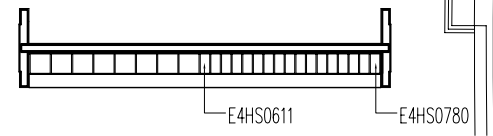
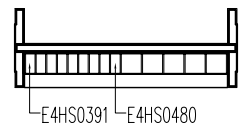
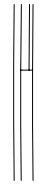

4/F FLOOR PLAN

FLOOR LEVEL  
▽

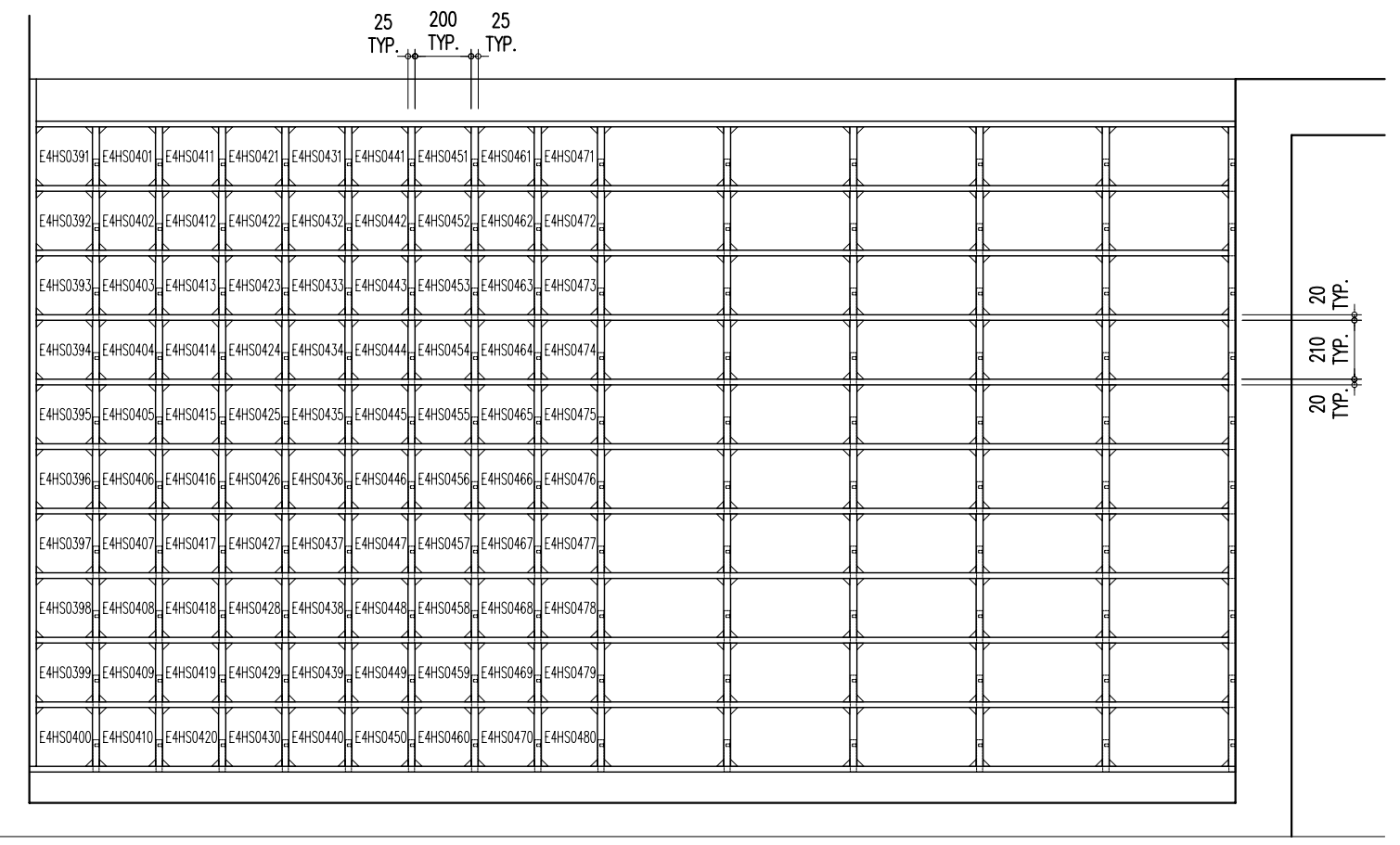

E4HS0391 ~ E4HS0480  
4/F ELEVATION A

FLOOR LEVEL  
▽

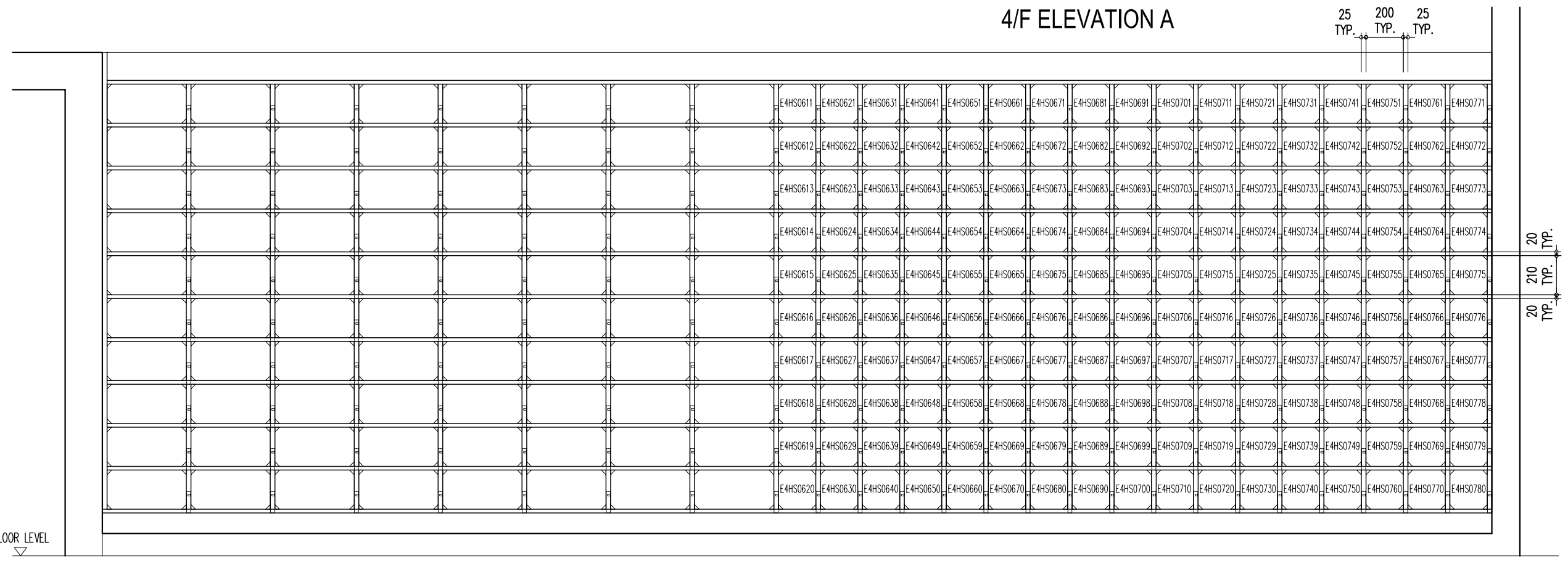

E4HS0611 ~ E4HS0780  
4/F ELEVATION B



FLOOR LEVEL

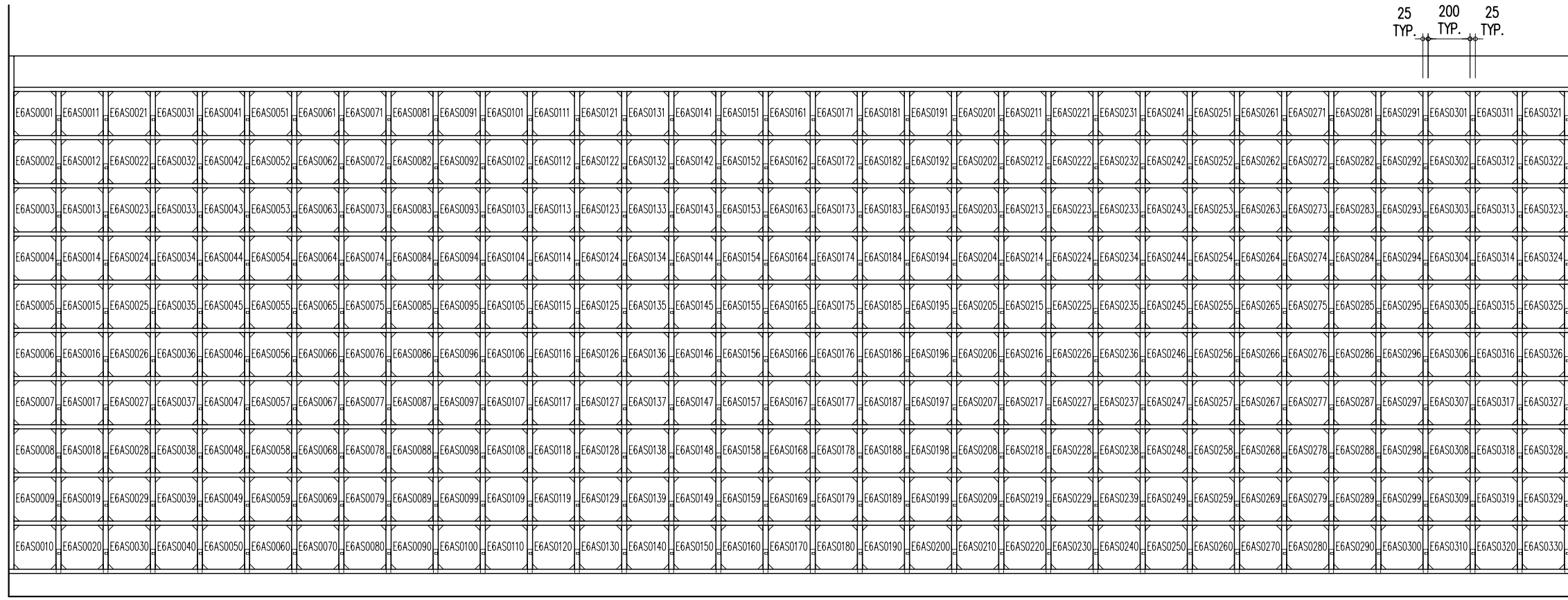

E6AS0001 ~ E6AS0330  
6/F ELEVATION A

25 TYP. 200 TYP. 25 TYP.

20 TYP. 210 TYP. 20 TYP.

FLOOR LEVEL

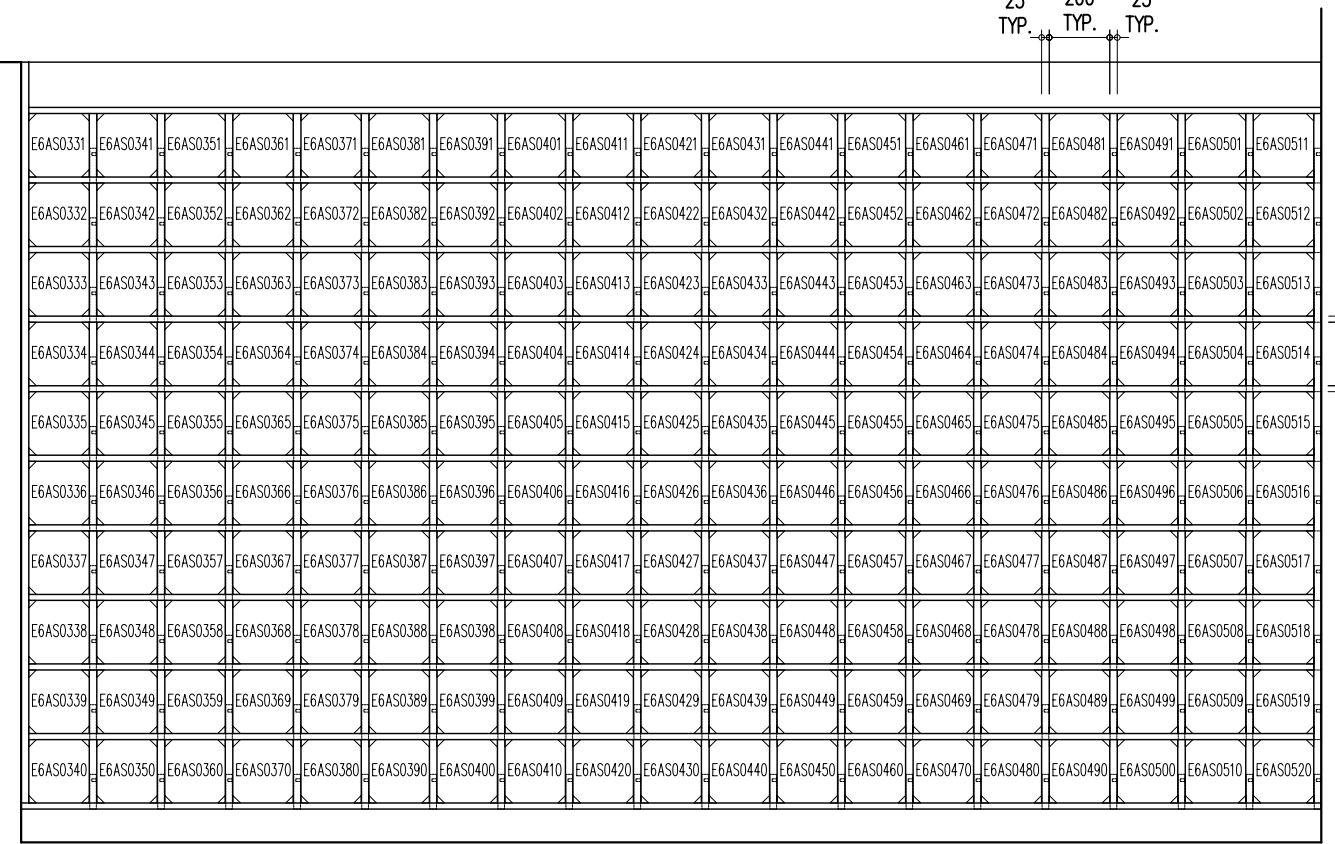

E6AS0331 ~ E6AS0520  
6/F ELEVATION B

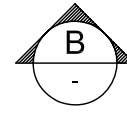
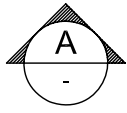
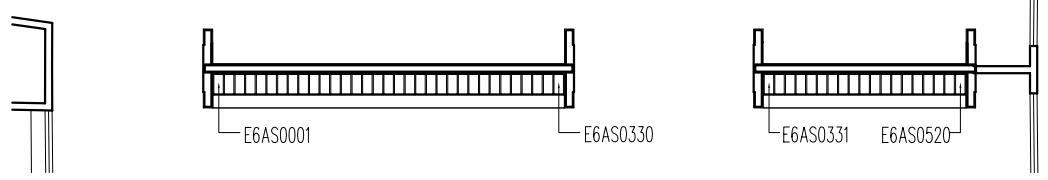

6/F FLOOR PLAN





E6BS0001	E6BS0011	E6BS0021	E6BS0031	E6BS0041	E6BS0051	E6BS0061	E6BS0071	E6BS0081	E6BS0091	E6BS0101	E6BS0111	E6BS0121	E6BS0131	E6BS0141	E6BS0151	E6BS0161	E6BS0171	E6BS0181	E6BS0191	E6BS0201	E6BS0211	E6BS0221	E6BS0231	E6BS0241	E6BS0251	E6BS0261	E6BS0271	E6BS0281	E6BS0291	E6BS0301	E6BS0311	E6BS0321	E6BS0331	E6BS0341
E6BS0002	E6BS0012	E6BS0022	E6BS0032	E6BS0042	E6BS0052	E6BS0062	E6BS0072	E6BS0082	E6BS0092	E6BS0102	E6BS0112	E6BS0122	E6BS0132	E6BS0142	E6BS0152	E6BS0162	E6BS0172	E6BS0182	E6BS0192	E6BS0202	E6BS0212	E6BS0222	E6BS0232	E6BS0242	E6BS0252	E6BS0262	E6BS0272	E6BS0282	E6BS0292	E6BS0302	E6BS0312	E6BS0322	E6BS0332	E6BS0342
E6BS0003	E6BS0013	E6BS0023	E6BS0033	E6BS0043	E6BS0053	E6BS0063	E6BS0073	E6BS0083	E6BS0093	E6BS0103	E6BS0113	E6BS0123	E6BS0133	E6BS0143	E6BS0153	E6BS0163	E6BS0173	E6BS0183	E6BS0193	E6BS0203	E6BS0213	E6BS0223	E6BS0233	E6BS0243	E6BS0253	E6BS0263	E6BS0273	E6BS0283	E6BS0293	E6BS0303	E6BS0313	E6BS0323	E6BS0333	E6BS0343
E6BS0004	E6BS0014	E6BS0024	E6BS0034	E6BS0044	E6BS0054	E6BS0064	E6BS0074	E6BS0084	E6BS0094	E6BS0104	E6BS0114	E6BS0124	E6BS0134	E6BS0144	E6BS0154	E6BS0164	E6BS0174	E6BS0184	E6BS0194	E6BS0204	E6BS0214	E6BS0224	E6BS0234	E6BS0244	E6BS0254	E6BS0264	E6BS0274	E6BS0284	E6BS0294	E6BS0304	E6BS0314	E6BS0324	E6BS0334	E6BS0344
E6BS0005	E6BS0015	E6BS0025	E6BS0035	E6BS0045	E6BS0055	E6BS0065	E6BS0075	E6BS0085	E6BS0095	E6BS0105	E6BS0115	E6BS0125	E6BS0135	E6BS0145	E6BS0155	E6BS0165	E6BS0175	E6BS0185	E6BS0195	E6BS0205	E6BS0215	E6BS0225	E6BS0235	E6BS0245	E6BS0255	E6BS0265	E6BS0275	E6BS0285	E6BS0295	E6BS0305	E6BS0315	E6BS0325	E6BS0335	E6BS0345
E6BS0006	E6BS0016	E6BS0026	E6BS0036	E6BS0046	E6BS0056	E6BS0066	E6BS0076	E6BS0086	E6BS0096	E6BS0106	E6BS0116	E6BS0126	E6BS0136	E6BS0146	E6BS0156	E6BS0166	E6BS0176	E6BS0186	E6BS0196	E6BS0206	E6BS0216	E6BS0226	E6BS0236	E6BS0246	E6BS0256	E6BS0266	E6BS0276	E6BS0286	E6BS0296	E6BS0306	E6BS0316	E6BS0326	E6BS0336	E6BS0346
E6BS0007	E6BS0017	E6BS0027	E6BS0037	E6BS0047	E6BS0057	E6BS0067	E6BS0077	E6BS0087	E6BS0097	E6BS0107	E6BS0117	E6BS0127	E6BS0137	E6BS0147	E6BS0157	E6BS0167	E6BS0177	E6BS0187	E6BS0197	E6BS0207	E6BS0217	E6BS0227	E6BS0237	E6BS0247	E6BS0257	E6BS0267	E6BS0277	E6BS0287	E6BS0297	E6BS0307	E6BS0317	E6BS0327	E6BS0337	E6BS0347
E6BS0008	E6BS0018	E6BS0028	E6BS0038	E6BS0048	E6BS0058	E6BS0068	E6BS0078	E6BS0088	E6BS0098	E6BS0108	E6BS0118	E6BS0128	E6BS0138	E6BS0148	E6BS0158	E6BS0168	E6BS0178	E6BS0188	E6BS0198	E6BS0208	E6BS0218	E6BS0228	E6BS0238	E6BS0248	E6BS0258	E6BS0268	E6BS0278	E6BS0288	E6BS0298	E6BS0308	E6BS0318	E6BS0328	E6BS0338	E6BS0348
E6BS0009	E6BS0019	E6BS0029	E6BS0039	E6BS0049	E6BS0059	E6BS0069	E6BS0079	E6BS0089	E6BS0099	E6BS0109	E6BS0119	E6BS0129	E6BS0139	E6BS0149	E6BS0159	E6BS0169	E6BS0179	E6BS0189	E6BS0199	E6BS0209	E6BS0219	E6BS0229	E6BS0239	E6BS0249	E6BS0259	E6BS0269	E6BS0279	E6BS0289	E6BS0299	E6BS0309	E6BS0319	E6BS0329	E6BS0339	E6BS0349
E6BS0010	E6BS0020	E6BS0030	E6BS0040	E6BS0050	E6BS0060	E6BS0070	E6BS0080	E6BS0090	E6BS0100	E6BS0110	E6BS0120	E6BS0130	E6BS0140	E6BS0150	E6BS0160	E6BS0170	E6BS0180	E6BS0190	E6BS0200	E6BS0210	E6BS0220	E6BS0230	E6BS0240	E6BS0250	E6BS0260	E6BS0270	E6BS0280	E6BS0290	E6BS0300	E6BS0310	E6BS0320	E6BS0330	E6BS0340	E6BS0350

25 TYP. 200 TYP. 25 TYP.

20 TYP. 210 TYP. 20 TYP.

FLOOR LEVEL

E6BS0001 ~ E6BS0350  
6/F ELEVATION A

E6BS0351	E6BS0361	E6BS0371	E6BS0381	E6BS0391	E6BS0401	E6BS0411	E6BS0421	E6BS0431	E6BS0441	E6BS0451	E6BS0461	E6BS0471	E6BS0481	E6BS0491	E6BS0501	E6BS0511	E6BS0521	E6BS0531
E6BS0352	E6BS0362	E6BS0372	E6BS0382	E6BS0392	E6BS0402	E6BS0412	E6BS0422	E6BS0432	E6BS0442	E6BS0452	E6BS0462	E6BS0472	E6BS0482	E6BS0492	E6BS0502	E6BS0512	E6BS0522	E6BS0532
E6BS0353	E6BS0363	E6BS0373	E6BS0383	E6BS0393	E6BS0403	E6BS0413	E6BS0423	E6BS0433	E6BS0443	E6BS0453	E6BS0463	E6BS0473	E6BS0483	E6BS0493	E6BS0503	E6BS0513	E6BS0523	E6BS0533
E6BS0354	E6BS0364	E6BS0374	E6BS0384	E6BS0394	E6BS0404	E6BS0414	E6BS0424	E6BS0434	E6BS0444	E6BS0454	E6BS0464	E6BS0474	E6BS0484	E6BS0494	E6BS0504	E6BS0514	E6BS0524	E6BS0534
E6BS0355	E6BS0365	E6BS0375	E6BS0385	E6BS0395	E6BS0405	E6BS0415	E6BS0425	E6BS0435	E6BS0445	E6BS0455	E6BS0465	E6BS0475	E6BS0485	E6BS0495	E6BS0505	E6BS0515	E6BS0525	E6BS0535
E6BS0356	E6BS0366	E6BS0376	E6BS0386	E6BS0396	E6BS0406	E6BS0416	E6BS0426	E6BS0436	E6BS0446	E6BS0456	E6BS0466	E6BS0476	E6BS0486	E6BS0496	E6BS0506	E6BS0516	E6BS0526	E6BS0536
E6BS0357	E6BS0367	E6BS0377	E6BS0387	E6BS0397	E6BS0407	E6BS0417	E6BS0427	E6BS0437	E6BS0447	E6BS0457	E6BS0467	E6BS0477	E6BS0487	E6BS0497	E6BS0507	E6BS0517	E6BS0527	E6BS0537
E6BS0358	E6BS0368	E6BS0378	E6BS0388	E6BS0398	E6BS0408	E6BS0418	E6BS0428	E6BS0438	E6BS0448	E6BS0458	E6BS0468	E6BS0478	E6BS0488	E6BS0498	E6BS0508	E6BS0518	E6BS0528	E6BS0538
E6BS0359	E6BS0369	E6BS0379	E6BS0389	E6BS0399	E6BS0409	E6BS0419	E6BS0429	E6BS0439	E6BS0449	E6BS0459	E6BS0469	E6BS0479	E6BS0489	E6BS0499	E6BS0509	E6BS0519	E6BS0529	E6BS0539
E6BS0360	E6BS0370	E6BS0380	E6BS0390	E6BS0400	E6BS0410	E6BS0420	E6BS0430	E6BS0440	E6BS0450	E6BS0460	E6BS0470	E6BS0480	E6BS0490	E6BS0500	E6BS0510	E6BS0520	E6BS0530	E6BS0540

25 TYP. 200 TYP. 25 TYP.

20 TYP. 210 TYP. 20 TYP.

FLOOR LEVEL

E6BS0351 ~ E6BS0540  
6/F ELEVATION B

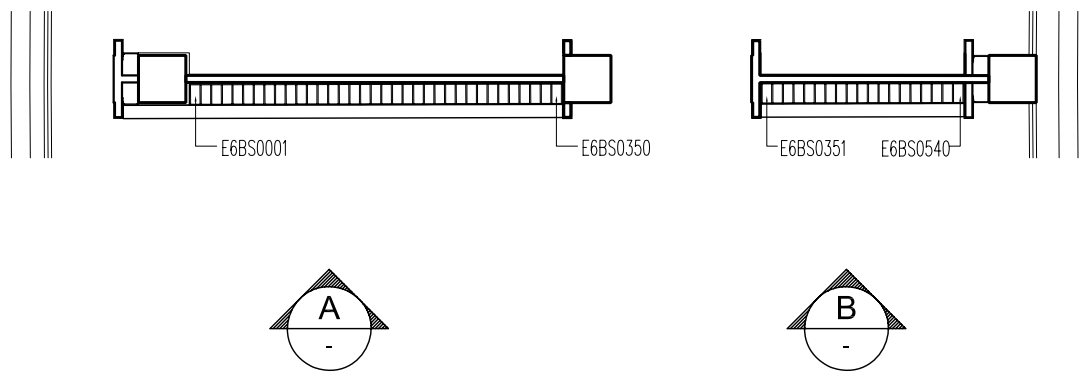

6/F FLOOR PLAN

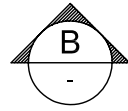
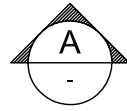
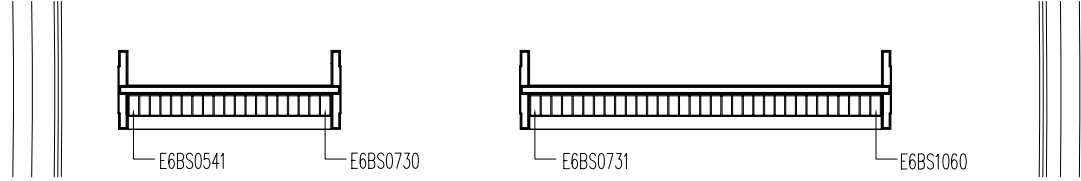

6/F FLOOR PLAN

FLOOR LEVEL

E6BS0541	E6BS0551	E6BS0561	E6BS0571	E6BS0581	E6BS0591	E6BS0601	E6BS0611	E6BS0621	E6BS0631	E6BS0641	E6BS0651	E6BS0661	E6BS0671	E6BS0681	E6BS0691	E6BS0701	E6BS0711	E6BS0721
E6BS0542	E6BS0552	E6BS0562	E6BS0572	E6BS0582	E6BS0592	E6BS0602	E6BS0612	E6BS0622	E6BS0632	E6BS0642	E6BS0652	E6BS0662	E6BS0672	E6BS0682	E6BS0692	E6BS0702	E6BS0712	E6BS0722
E6BS0543	E6BS0553	E6BS0563	E6BS0573	E6BS0583	E6BS0593	E6BS0603	E6BS0613	E6BS0623	E6BS0633	E6BS0643	E6BS0653	E6BS0663	E6BS0673	E6BS0683	E6BS0693	E6BS0703	E6BS0713	E6BS0723
E6BS0544	E6BS0554	E6BS0564	E6BS0574	E6BS0584	E6BS0594	E6BS0604	E6BS0614	E6BS0624	E6BS0634	E6BS0644	E6BS0654	E6BS0664	E6BS0674	E6BS0684	E6BS0694	E6BS0704	E6BS0714	E6BS0724
E6BS0545	E6BS0555	E6BS0565	E6BS0575	E6BS0585	E6BS0595	E6BS0605	E6BS0615	E6BS0625	E6BS0635	E6BS0645	E6BS0655	E6BS0665	E6BS0675	E6BS0685	E6BS0695	E6BS0705	E6BS0715	E6BS0725
E6BS0546	E6BS0556	E6BS0566	E6BS0576	E6BS0586	E6BS0596	E6BS0606	E6BS0616	E6BS0626	E6BS0636	E6BS0646	E6BS0656	E6BS0666	E6BS0676	E6BS0686	E6BS0696	E6BS0706	E6BS0716	E6BS0726
E6BS0547	E6BS0557	E6BS0567	E6BS0577	E6BS0587	E6BS0597	E6BS0607	E6BS0617	E6BS0627	E6BS0637	E6BS0647	E6BS0657	E6BS0667	E6BS0677	E6BS0687	E6BS0697	E6BS0707	E6BS0717	E6BS0727
E6BS0548	E6BS0558	E6BS0568	E6BS0578	E6BS0588	E6BS0598	E6BS0608	E6BS0618	E6BS0628	E6BS0638	E6BS0648	E6BS0658	E6BS0668	E6BS0678	E6BS0688	E6BS0698	E6BS0708	E6BS0718	E6BS0728
E6BS0549	E6BS0559	E6BS0569	E6BS0579	E6BS0589	E6BS0599	E6BS0609	E6BS0619	E6BS0629	E6BS0639	E6BS0649	E6BS0659	E6BS0669	E6BS0679	E6BS0689	E6BS0699	E6BS0709	E6BS0719	E6BS0729
E6BS0550	E6BS0560	E6BS0570	E6BS0580	E6BS0590	E6BS0600	E6BS0610	E6BS0620	E6BS0630	E6BS0640	E6BS0650	E6BS0660	E6BS0670	E6BS0680	E6BS0690	E6BS0700	E6BS0710	E6BS0720	E6BS0730

25 TYP. 200 TYP. 25 TYP.

20 TYP.  
210 TYP.  
20 TYP.

E6BS0541 ~ E6BS0730  
6/F ELEVATION A

25 TYP. 200 TYP. 25 TYP.

FLOOR LEVEL

E6BS0731	E6BS0741	E6BS0751	E6BS0761	E6BS0771	E6BS0781	E6BS0791	E6BS0801	E6BS0811	E6BS0821	E6BS0831	E6BS0841	E6BS0851	E6BS0861	E6BS0871	E6BS0881	E6BS0891	E6BS0901	E6BS0911	E6BS0921	E6BS0931	E6BS0941	E6BS0951	E6BS0961	E6BS0971	E6BS0981	E6BS0991	E6BS1001	E6BS1011	E6BS1021	E6BS1031	E6BS1041	E6BS1051
E6BS0732	E6BS0742	E6BS0752	E6BS0762	E6BS0772	E6BS0782	E6BS0792	E6BS0802	E6BS0812	E6BS0822	E6BS0832	E6BS0842	E6BS0852	E6BS0862	E6BS0872	E6BS0882	E6BS0892	E6BS0902	E6BS0912	E6BS0922	E6BS0932	E6BS0942	E6BS0952	E6BS0962	E6BS0972	E6BS0982	E6BS0992	E6BS1002	E6BS1012	E6BS1022	E6BS1032	E6BS1042	E6BS1052
E6BS0733	E6BS0743	E6BS0753	E6BS0763	E6BS0773	E6BS0783	E6BS0793	E6BS0803	E6BS0813	E6BS0823	E6BS0833	E6BS0843	E6BS0853	E6BS0863	E6BS0873	E6BS0883	E6BS0893	E6BS0903	E6BS0913	E6BS0923	E6BS0933	E6BS0943	E6BS0953	E6BS0963	E6BS0973	E6BS0983	E6BS0993	E6BS1003	E6BS1013	E6BS1023	E6BS1033	E6BS1043	E6BS1053
E6BS0734	E6BS0744	E6BS0754	E6BS0764	E6BS0774	E6BS0784	E6BS0794	E6BS0804	E6BS0814	E6BS0824	E6BS0834	E6BS0844	E6BS0854	E6BS0864	E6BS0874	E6BS0884	E6BS0894	E6BS0904	E6BS0914	E6BS0924	E6BS0934	E6BS0944	E6BS0954	E6BS0964	E6BS0974	E6BS0984	E6BS0994	E6BS1004	E6BS1014	E6BS1024	E6BS1034	E6BS1044	E6BS1054
E6BS0735	E6BS0745	E6BS0755	E6BS0765	E6BS0775	E6BS0785	E6BS0795	E6BS0805	E6BS0815	E6BS0825	E6BS0835	E6BS0845	E6BS0855	E6BS0865	E6BS0875	E6BS0885	E6BS0895	E6BS0905	E6BS0915	E6BS0925	E6BS0935	E6BS0945	E6BS0955	E6BS0965	E6BS0975	E6BS0985	E6BS0995	E6BS1005	E6BS1015	E6BS1025	E6BS1035	E6BS1045	E6BS1055
E6BS0736	E6BS0746	E6BS0756	E6BS0766	E6BS0776	E6BS0786	E6BS0796	E6BS0806	E6BS0816	E6BS0826	E6BS0836	E6BS0846	E6BS0856	E6BS0866	E6BS0876	E6BS0886	E6BS0896	E6BS0906	E6BS0916	E6BS0926	E6BS0936	E6BS0946	E6BS0956	E6BS0966	E6BS0976	E6BS0986	E6BS0996	E6BS1006	E6BS1016	E6BS1026	E6BS1036	E6BS1046	E6BS1056
E6BS0737	E6BS0747	E6BS0757	E6BS0767	E6BS0777	E6BS0787	E6BS0797	E6BS0807	E6BS0817	E6BS0827	E6BS0837	E6BS0847	E6BS0857	E6BS0867	E6BS0877	E6BS0887	E6BS0897	E6BS0907	E6BS0917	E6BS0927	E6BS0937	E6BS0947	E6BS0957	E6BS0967	E6BS0977	E6BS0987	E6BS0997	E6BS1007	E6BS1017	E6BS1027	E6BS1037	E6BS1047	E6BS1057
E6BS0738	E6BS0748	E6BS0758	E6BS0768	E6BS0778	E6BS0788	E6BS0798	E6BS0808	E6BS0818	E6BS0828	E6BS0838	E6BS0848	E6BS0858	E6BS0868	E6BS0878	E6BS0888	E6BS0898	E6BS0908	E6BS0918	E6BS0928	E6BS0938	E6BS0948	E6BS0958	E6BS0968	E6BS0978	E6BS0988	E6BS0998	E6BS1008	E6BS1018	E6BS1028	E6BS1038	E6BS1048	E6BS1058
E6BS0739	E6BS0749	E6BS0759	E6BS0769	E6BS0779	E6BS0789	E6BS0799	E6BS0809	E6BS0819	E6BS0829	E6BS0839	E6BS0849	E6BS0859	E6BS0869	E6BS0879	E6BS0889	E6BS0899	E6BS0909	E6BS0919	E6BS0929	E6BS0939	E6BS0949	E6BS0959	E6BS0969	E6BS0979	E6BS0989	E6BS0999	E6BS1009	E6BS1019	E6BS1029	E6BS1039	E6BS1049	E6BS1059
E6BS0740	E6BS0750	E6BS0760	E6BS0770	E6BS0780	E6BS0790	E6BS0800	E6BS0810	E6BS0820	E6BS0830	E6BS0840	E6BS0850	E6BS0860	E6BS0870	E6BS0880	E6BS0890	E6BS0900	E6BS0910	E6BS0920	E6BS0930	E6BS0940	E6BS0950	E6BS0960	E6BS0970	E6BS0980	E6BS0990	E6BS1000	E6BS1010	E6BS1020	E6BS1030	E6BS1040	E6BS1050	E6BS1060

20 TYP.  
210 TYP.  
20 TYP.

E6BS0731 ~ E6BS1060  
6/F ELEVATION B

FLOOR LEVEL



E6CS0001 ~ E6CS0330  
6/F ELEVATION A

25 TYP. 200 TYP. 25 TYP.

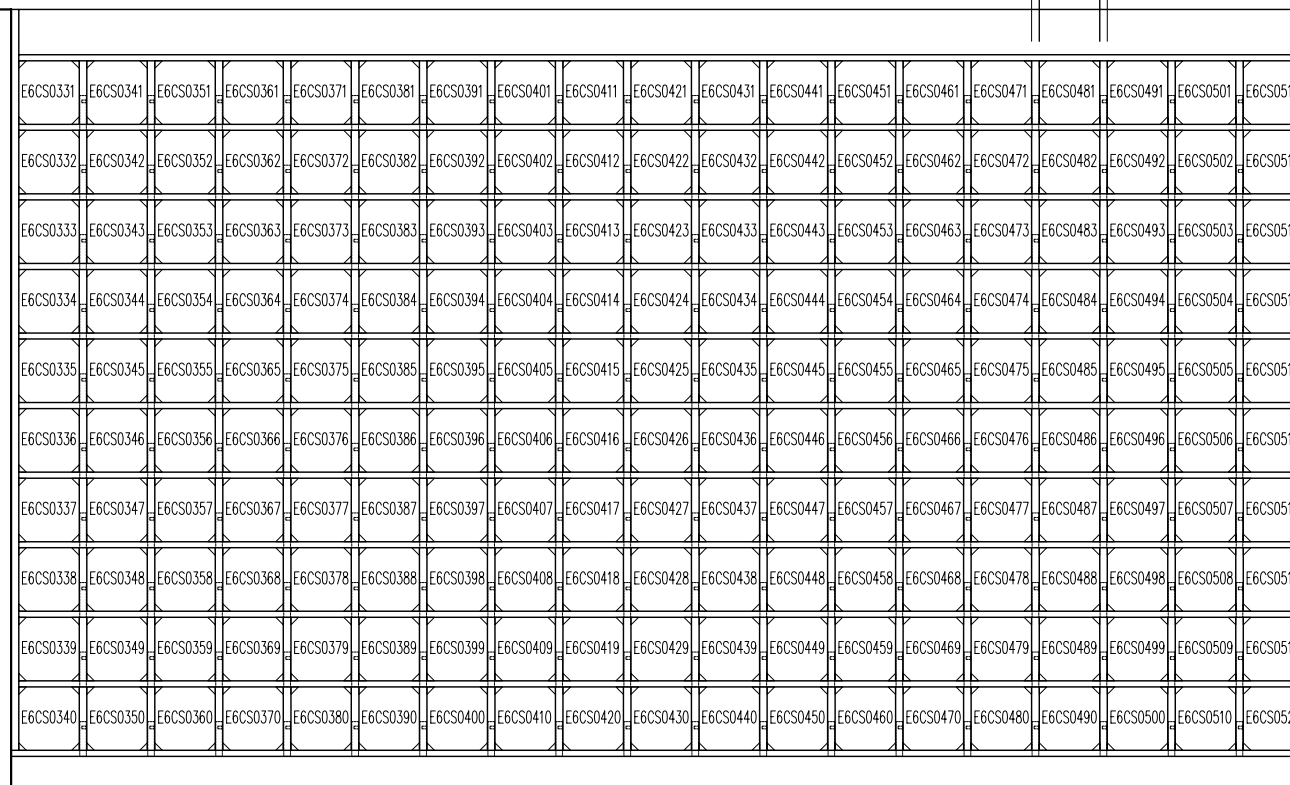

E6CS0331 ~ E6CS0520  
6/F ELEVATION B

6/F FLOOR PLAN

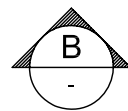
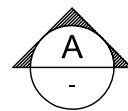
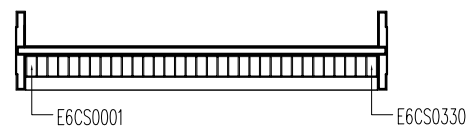

FLOOR LEVEL



E6DS0001	E6DS0011	E6DS0021	E6DS0031	E6DS0041	E6DS0051	E6DS0061	E6DS0071	E6DS0081	E6DS0091	E6DS0101	E6DS0111	E6DS0121	E6DS0131	E6DS0141	E6DS0151	E6DS0161	E6DS0171	E6DS0181	E6DS0191	E6DS0201	E6DS0211	E6DS0221	E6DS0231	E6DS0241	E6DS0251	E6DS0261	E6DS0271	E6DS0281	E6DS0291	E6DS0301	E6DS0311	E6DS0321	E6DS0331	E6DS0341
E6DS0002	E6DS0012	E6DS0022	E6DS0032	E6DS0042	E6DS0052	E6DS0062	E6DS0072	E6DS0082	E6DS0092	E6DS0102	E6DS0112	E6DS0122	E6DS0132	E6DS0142	E6DS0152	E6DS0162	E6DS0172	E6DS0182	E6DS0192	E6DS0202	E6DS0212	E6DS0222	E6DS0232	E6DS0242	E6DS0252	E6DS0262	E6DS0272	E6DS0282	E6DS0292	E6DS0302	E6DS0312	E6DS0322	E6DS0332	E6DS0342
E6DS0003	E6DS0013	E6DS0023	E6DS0033	E6DS0043	E6DS0053	E6DS0063	E6DS0073	E6DS0083	E6DS0093	E6DS0103	E6DS0113	E6DS0123	E6DS0133	E6DS0143	E6DS0153	E6DS0163	E6DS0173	E6DS0183	E6DS0193	E6DS0203	E6DS0213	E6DS0223	E6DS0233	E6DS0243	E6DS0253	E6DS0263	E6DS0273	E6DS0283	E6DS0293	E6DS0303	E6DS0313	E6DS0323	E6DS0333	E6DS0343
E6DS0004	E6DS0014	E6DS0024	E6DS0034	E6DS0044	E6DS0054	E6DS0064	E6DS0074	E6DS0084	E6DS0094	E6DS0104	E6DS0114	E6DS0124	E6DS0134	E6DS0144	E6DS0154	E6DS0164	E6DS0174	E6DS0184	E6DS0194	E6DS0204	E6DS0214	E6DS0224	E6DS0234	E6DS0244	E6DS0254	E6DS0264	E6DS0274	E6DS0284	E6DS0294	E6DS0304	E6DS0314	E6DS0324	E6DS0334	E6DS0344
E6DS0005	E6DS0015	E6DS0025	E6DS0035	E6DS0045	E6DS0055	E6DS0065	E6DS0075	E6DS0085	E6DS0095	E6DS0105	E6DS0115	E6DS0125	E6DS0135	E6DS0145	E6DS0155	E6DS0165	E6DS0175	E6DS0185	E6DS0195	E6DS0205	E6DS0215	E6DS0225	E6DS0235	E6DS0245	E6DS0255	E6DS0265	E6DS0275	E6DS0285	E6DS0295	E6DS0305	E6DS0315	E6DS0325	E6DS0335	E6DS0345
E6DS0006	E6DS0016	E6DS0026	E6DS0036	E6DS0046	E6DS0056	E6DS0066	E6DS0076	E6DS0086	E6DS0096	E6DS0106	E6DS0116	E6DS0126	E6DS0136	E6DS0146	E6DS0156	E6DS0166	E6DS0176	E6DS0186	E6DS0196	E6DS0206	E6DS0216	E6DS0226	E6DS0236	E6DS0246	E6DS0256	E6DS0266	E6DS0276	E6DS0286	E6DS0296	E6DS0306	E6DS0316	E6DS0326	E6DS0336	E6DS0346
E6DS0007	E6DS0017	E6DS0027	E6DS0037	E6DS0047	E6DS0057	E6DS0067	E6DS0077	E6DS0087	E6DS0097	E6DS0107	E6DS0117	E6DS0127	E6DS0137	E6DS0147	E6DS0157	E6DS0167	E6DS0177	E6DS0187	E6DS0197	E6DS0207	E6DS0217	E6DS0227	E6DS0237	E6DS0247	E6DS0257	E6DS0267	E6DS0277	E6DS0287	E6DS0297	E6DS0307	E6DS0317	E6DS0327	E6DS0337	E6DS0347
E6DS0008	E6DS0018	E6DS0028	E6DS0038	E6DS0048	E6DS0058	E6DS0068	E6DS0078	E6DS0088	E6DS0098	E6DS0108	E6DS0118	E6DS0128	E6DS0138	E6DS0148	E6DS0158	E6DS0168	E6DS0178	E6DS0188	E6DS0198	E6DS0208	E6DS0218	E6DS0228	E6DS0238	E6DS0248	E6DS0258	E6DS0268	E6DS0278	E6DS0288	E6DS0298	E6DS0308	E6DS0318	E6DS0328	E6DS0338	E6DS0348
E6DS0009	E6DS0019	E6DS0029	E6DS0039	E6DS0049	E6DS0059	E6DS0069	E6DS0079	E6DS0089	E6DS0099	E6DS0109	E6DS0119	E6DS0129	E6DS0139	E6DS0149	E6DS0159	E6DS0169	E6DS0179	E6DS0189	E6DS0199	E6DS0209	E6DS0219	E6DS0229	E6DS0239	E6DS0249	E6DS0259	E6DS0269	E6DS0279	E6DS0289	E6DS0299	E6DS0309	E6DS0319	E6DS0329	E6DS0339	E6DS0349
E6DS0010	E6DS0020	E6DS0030	E6DS0040	E6DS0050	E6DS0060	E6DS0070	E6DS0080	E6DS0090	E6DS0100	E6DS0110	E6DS0120	E6DS0130	E6DS0140	E6DS0150	E6DS0160	E6DS0170	E6DS0180	E6DS0190	E6DS0200	E6DS0210	E6DS0220	E6DS0230	E6DS0240	E6DS0250	E6DS0260	E6DS0270	E6DS0280	E6DS0290	E6DS0300	E6DS0310	E6DS0320	E6DS0330	E6DS0340	E6DS0350

25 TYP. 200 TYP. 25 TYP.

20 TYP. 210 TYP. 20 TYP.

FLOOR LEVEL

E6DS0001 ~ E6DS0350  
6/F ELEVATION A

E6DS0351	E6DS0361	E6DS0371	E6DS0381	E6DS0391	E6DS0401	E6DS0411	E6DS0421	E6DS0431	E6DS0441	E6DS0451	E6DS0461	E6DS0471	E6DS0481	E6DS0491	E6DS0501	E6DS0511	E6DS0521	E6DS0531
E6DS0352	E6DS0362	E6DS0372	E6DS0382	E6DS0392	E6DS0402	E6DS0412	E6DS0422	E6DS0432	E6DS0442	E6DS0452	E6DS0462	E6DS0472	E6DS0482	E6DS0492	E6DS0502	E6DS0512	E6DS0522	E6DS0532
E6DS0353	E6DS0363	E6DS0373	E6DS0383	E6DS0393	E6DS0403	E6DS0413	E6DS0423	E6DS0433	E6DS0443	E6DS0453	E6DS0463	E6DS0473	E6DS0483	E6DS0493	E6DS0503	E6DS0513	E6DS0523	E6DS0533
E6DS0354	E6DS0364	E6DS0374	E6DS0384	E6DS0394	E6DS0404	E6DS0414	E6DS0424	E6DS0434	E6DS0444	E6DS0454	E6DS0464	E6DS0474	E6DS0484	E6DS0494	E6DS0504	E6DS0514	E6DS0524	E6DS0534
E6DS0355	E6DS0365	E6DS0375	E6DS0385	E6DS0395	E6DS0405	E6DS0415	E6DS0425	E6DS0435	E6DS0445	E6DS0455	E6DS0465	E6DS0475	E6DS0485	E6DS0495	E6DS0505	E6DS0515	E6DS0525	E6DS0535
E6DS0356	E6DS0366	E6DS0376	E6DS0386	E6DS0396	E6DS0406	E6DS0416	E6DS0426	E6DS0436	E6DS0446	E6DS0456	E6DS0466	E6DS0476	E6DS0486	E6DS0496	E6DS0506	E6DS0516	E6DS0526	E6DS0536
E6DS0357	E6DS0367	E6DS0377	E6DS0387	E6DS0397	E6DS0407	E6DS0417	E6DS0427	E6DS0437	E6DS0447	E6DS0457	E6DS0467	E6DS0477	E6DS0487	E6DS0497	E6DS0507	E6DS0517	E6DS0527	E6DS0537
E6DS0358	E6DS0368	E6DS0378	E6DS0388	E6DS0398	E6DS0408	E6DS0418	E6DS0428	E6DS0438	E6DS0448	E6DS0458	E6DS0468	E6DS0478	E6DS0488	E6DS0498	E6DS0508	E6DS0518	E6DS0528	E6DS0538
E6DS0359	E6DS0369	E6DS0379	E6DS0389	E6DS0399	E6DS0409	E6DS0419	E6DS0429	E6DS0439	E6DS0449	E6DS0459	E6DS0469	E6DS0479	E6DS0489	E6DS0499	E6DS0509	E6DS0519	E6DS0529	E6DS0539
E6DS0360	E6DS0370	E6DS0380	E6DS0390	E6DS0400	E6DS0410	E6DS0420	E6DS0430	E6DS0440	E6DS0450	E6DS0460	E6DS0470	E6DS0480	E6DS0490	E6DS0500	E6DS0510	E6DS0520	E6DS0530	E6DS0540

25 TYP. 200 TYP. 25 TYP.

20 TYP. 210 TYP. 20 TYP.

FLOOR LEVEL

E6DS0351 ~ E6DS0540  
6/F ELEVATION B

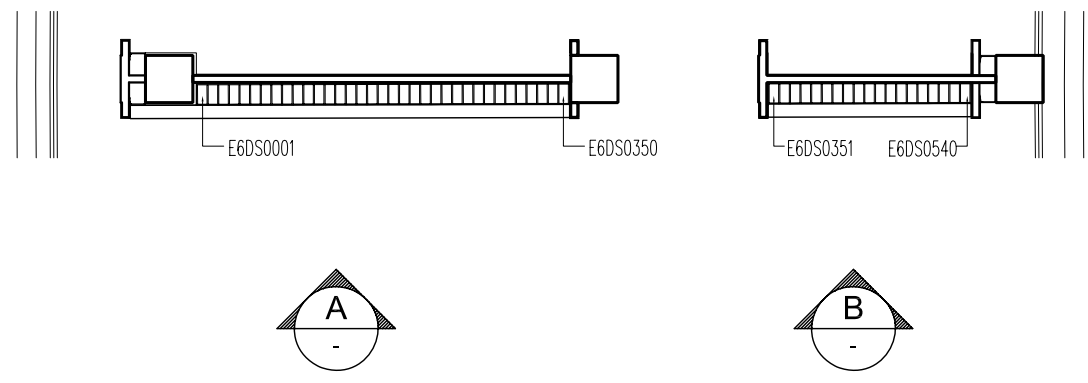

6/F FLOOR PLAN

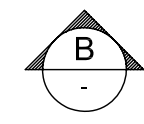
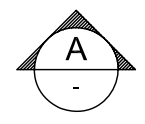





FLOOR LEVEL

E6ES0001	E6ES0011	E6ES0021	E6ES0031	E6ES0041	E6ES0051	E6ES0061	E6ES0071	E6ES0081	E6ES0091	E6ES0101	E6ES0111	E6ES0121	E6ES0131	E6ES0141	E6ES0151	E6ES0161	E6ES0171	E6ES0181	E6ES0191	E6ES0201	E6ES0211	E6ES0221	E6ES0231	E6ES0241	E6ES0251	E6ES0261	E6ES0271	E6ES0281	E6ES0291	E6ES0301	E6ES0311	E6ES0321
E6ES0002	E6ES0012	E6ES0022	E6ES0032	E6ES0042	E6ES0052	E6ES0062	E6ES0072	E6ES0082	E6ES0092	E6ES0102	E6ES0112	E6ES0122	E6ES0132	E6ES0142	E6ES0152	E6ES0162	E6ES0172	E6ES0182	E6ES0192	E6ES0202	E6ES0212	E6ES0222	E6ES0232	E6ES0242	E6ES0252	E6ES0262	E6ES0272	E6ES0282	E6ES0292	E6ES0302	E6ES0312	E6ES0322
E6ES0003	E6ES0013	E6ES0023	E6ES0033	E6ES0043	E6ES0053	E6ES0063	E6ES0073	E6ES0083	E6ES0093	E6ES0103	E6ES0113	E6ES0123	E6ES0133	E6ES0143	E6ES0153	E6ES0163	E6ES0173	E6ES0183	E6ES0193	E6ES0203	E6ES0213	E6ES0223	E6ES0233	E6ES0243	E6ES0253	E6ES0263	E6ES0273	E6ES0283	E6ES0293	E6ES0303	E6ES0313	E6ES0323
E6ES0004	E6ES0014	E6ES0024	E6ES0034	E6ES0044	E6ES0054	E6ES0064	E6ES0074	E6ES0084	E6ES0094	E6ES0104	E6ES0114	E6ES0124	E6ES0134	E6ES0144	E6ES0154	E6ES0164	E6ES0174	E6ES0184	E6ES0194	E6ES0204	E6ES0214	E6ES0224	E6ES0234	E6ES0244	E6ES0254	E6ES0264	E6ES0274	E6ES0284	E6ES0294	E6ES0304	E6ES0314	E6ES0324
E6ES0005	E6ES0015	E6ES0025	E6ES0035	E6ES0045	E6ES0055	E6ES0065	E6ES0075	E6ES0085	E6ES0095	E6ES0105	E6ES0115	E6ES0125	E6ES0135	E6ES0145	E6ES0155	E6ES0165	E6ES0175	E6ES0185	E6ES0195	E6ES0205	E6ES0215	E6ES0225	E6ES0235	E6ES0245	E6ES0255	E6ES0265	E6ES0275	E6ES0285	E6ES0295	E6ES0305	E6ES0315	E6ES0325
E6ES0006	E6ES0016	E6ES0026	E6ES0036	E6ES0046	E6ES0056	E6ES0066	E6ES0076	E6ES0086	E6ES0096	E6ES0106	E6ES0116	E6ES0126	E6ES0136	E6ES0146	E6ES0156	E6ES0166	E6ES0176	E6ES0186	E6ES0196	E6ES0206	E6ES0216	E6ES0226	E6ES0236	E6ES0246	E6ES0256	E6ES0266	E6ES0276	E6ES0286	E6ES0296	E6ES0306	E6ES0316	E6ES0326
E6ES0007	E6ES0017	E6ES0027	E6ES0037	E6ES0047	E6ES0057	E6ES0067	E6ES0077	E6ES0087	E6ES0097	E6ES0107	E6ES0117	E6ES0127	E6ES0137	E6ES0147	E6ES0157	E6ES0167	E6ES0177	E6ES0187	E6ES0197	E6ES0207	E6ES0217	E6ES0227	E6ES0237	E6ES0247	E6ES0257	E6ES0267	E6ES0277	E6ES0287	E6ES0297	E6ES0307	E6ES0317	E6ES0327
E6ES0008	E6ES0018	E6ES0028	E6ES0038	E6ES0048	E6ES0058	E6ES0068	E6ES0078	E6ES0088	E6ES0098	E6ES0108	E6ES0118	E6ES0128	E6ES0138	E6ES0148	E6ES0158	E6ES0168	E6ES0178	E6ES0188	E6ES0198	E6ES0208	E6ES0218	E6ES0228	E6ES0238	E6ES0248	E6ES0258	E6ES0268	E6ES0278	E6ES0288	E6ES0298	E6ES0308	E6ES0318	E6ES0328
E6ES0009	E6ES0019	E6ES0029	E6ES0039	E6ES0049	E6ES0059	E6ES0069	E6ES0079	E6ES0089	E6ES0099	E6ES0109	E6ES0119	E6ES0129	E6ES0139	E6ES0149	E6ES0159	E6ES0169	E6ES0179	E6ES0189	E6ES0199	E6ES0209	E6ES0219	E6ES0229	E6ES0239	E6ES0249	E6ES0259	E6ES0269	E6ES0279	E6ES0289	E6ES0299	E6ES0309	E6ES0319	E6ES0329
E6ES0010	E6ES0020	E6ES0030	E6ES0040	E6ES0050	E6ES0060	E6ES0070	E6ES0080	E6ES0090	E6ES0100	E6ES0110	E6ES0120	E6ES0130	E6ES0140	E6ES0150	E6ES0160	E6ES0170	E6ES0180	E6ES0190	E6ES0200	E6ES0210	E6ES0220	E6ES0230	E6ES0240	E6ES0250	E6ES0260	E6ES0270	E6ES0280	E6ES0290	E6ES0300	E6ES0310	E6ES0320	E6ES0330

25 TYP. 200 TYP. 25 TYP.

20 TYP. 210 TYP. 20 TYP.

E6ES0001 ~ E6ES0330  
6/F ELEVATION A

25 TYP. 200 TYP. 25 TYP.

20 TYP. 210 TYP. 20 TYP.

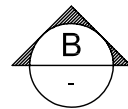
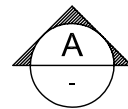
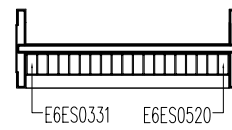
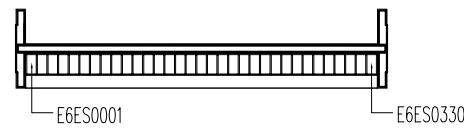

6/F FLOOR PLAN

FLOOR LEVEL

E6ES0331 ~ E6ES0520  
6/F ELEVATION B



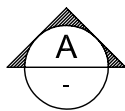
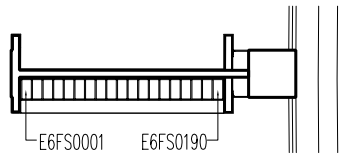

6/F FLOOR PLAN

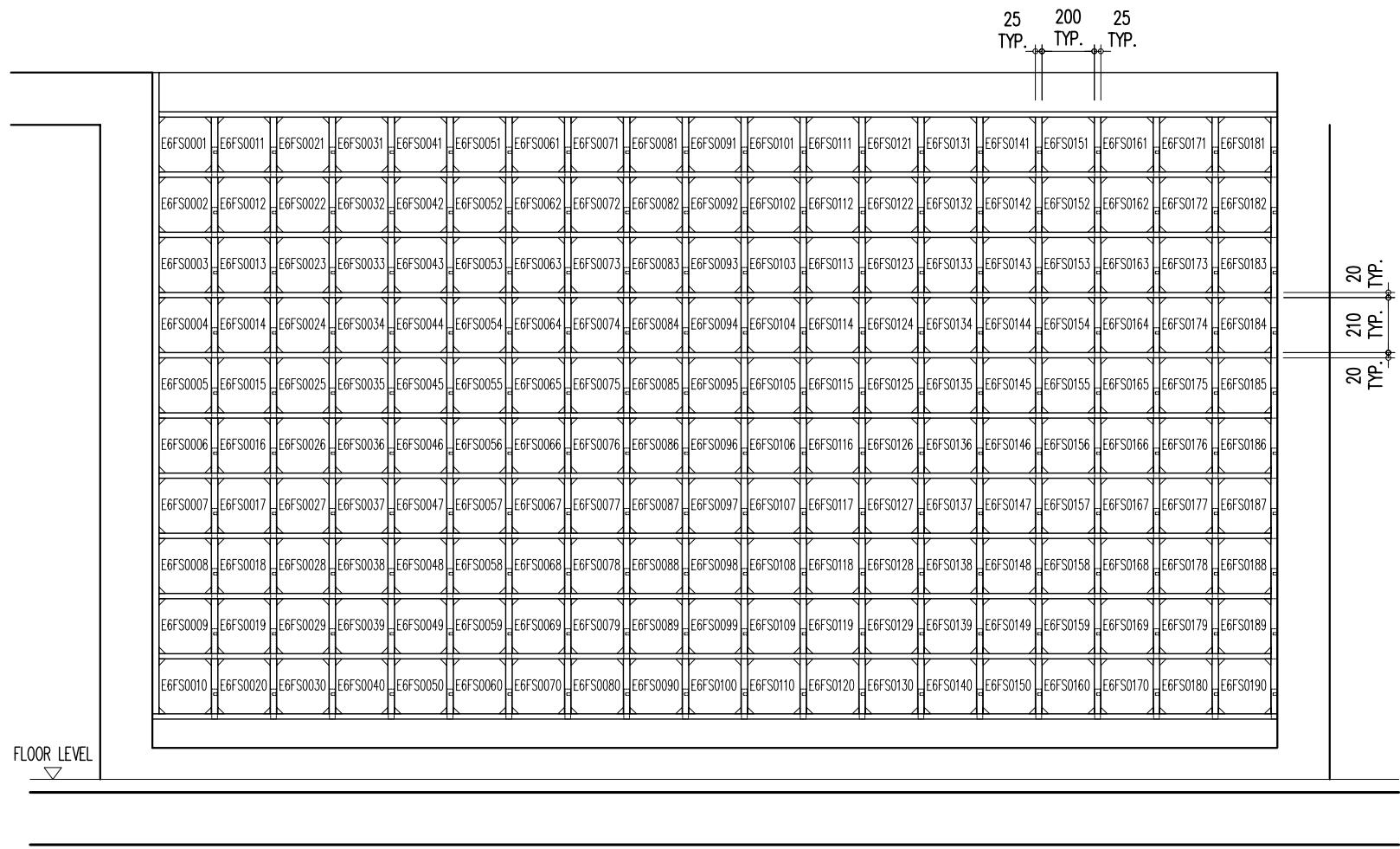

E6FS0001 ~ E6FS0190  
6/F ELEVATION A

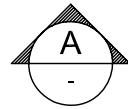
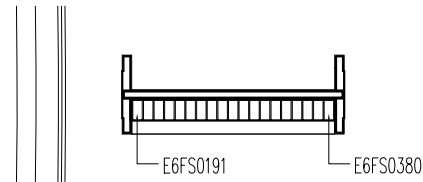

6/F FLOOR PLAN

FLOOR LEVEL  
▽

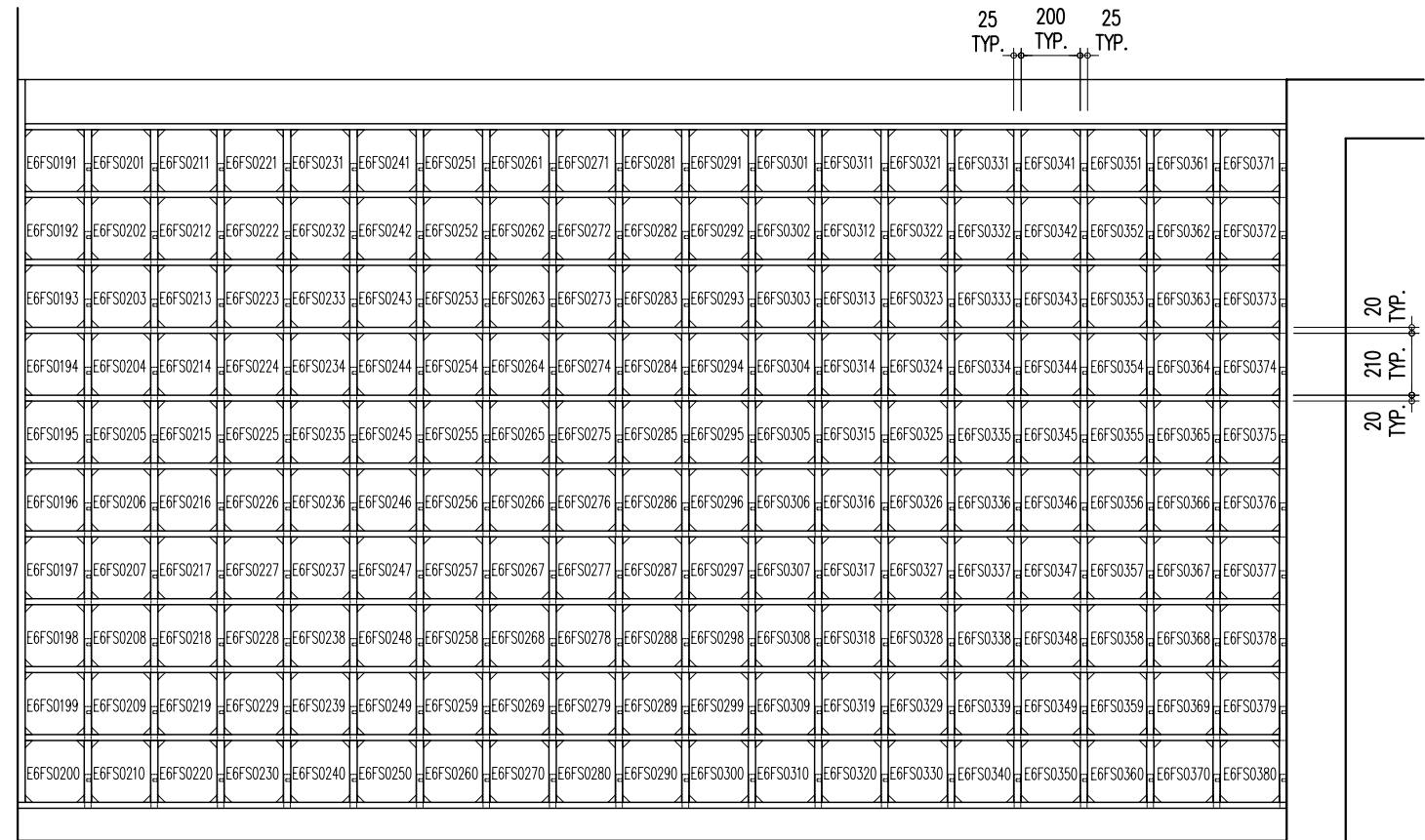

E6FS0191 ~ E6FS0380  
6/F ELEVATION A

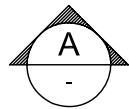

6/F FLOOR PLAN

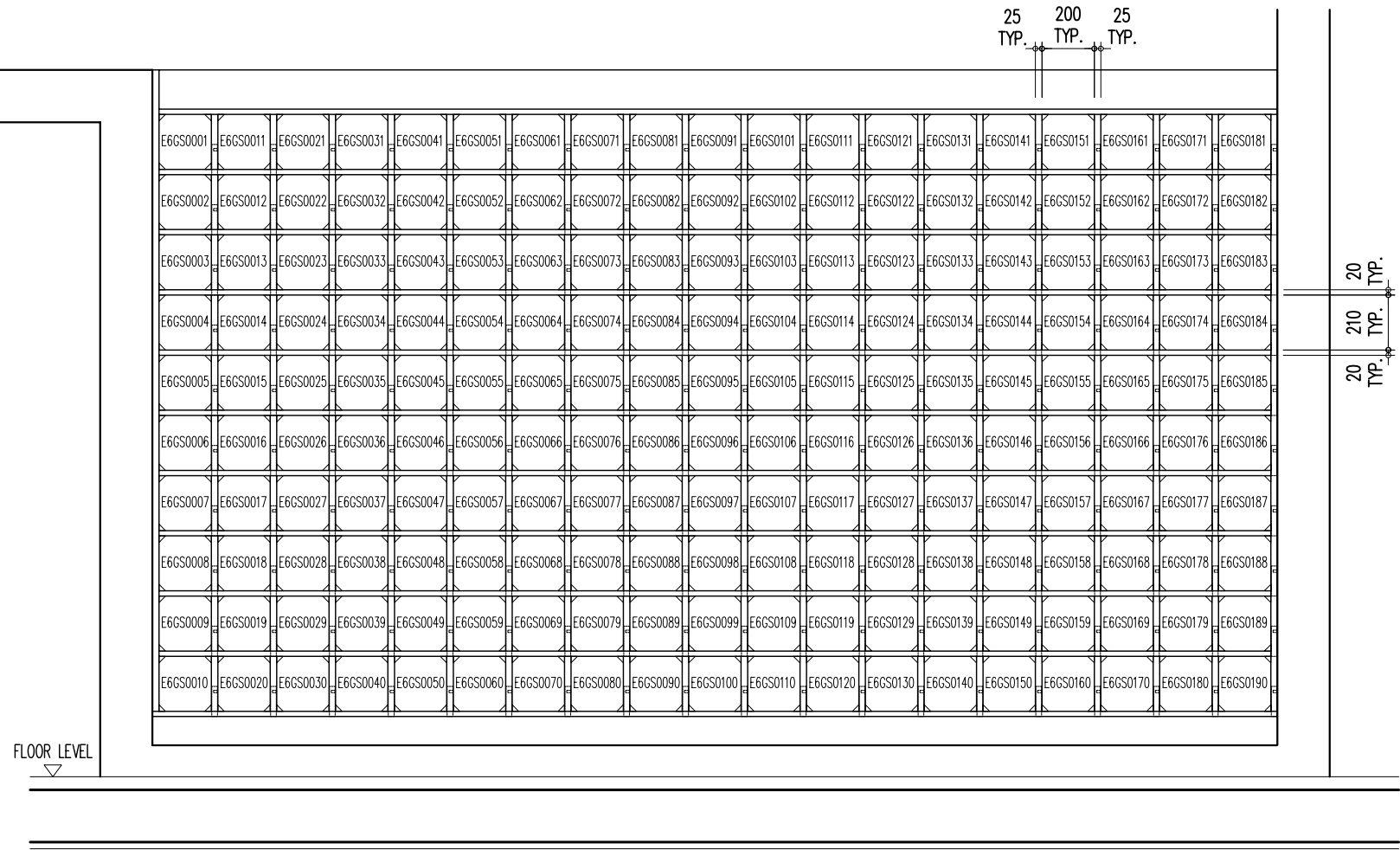

E6GS0001~ E6GS0190  
6/F ELEVATION A

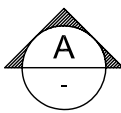
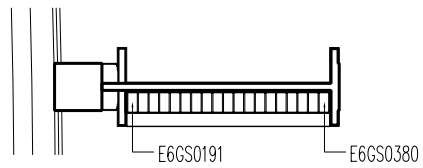

6/F FLOOR PLAN

FLOOR LEVEL  
▽

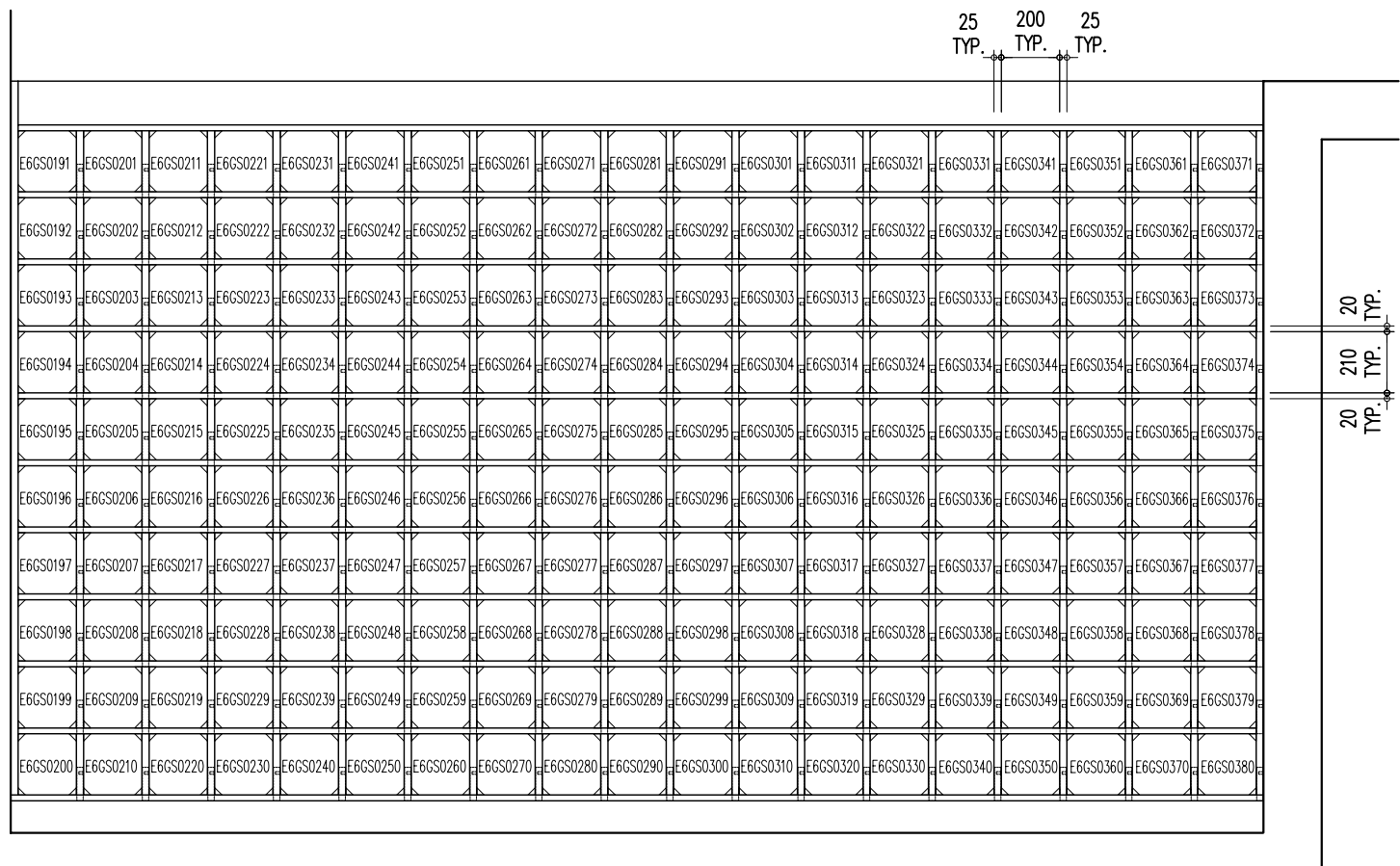

E6GS0191~ E6GS0380  
6/F ELEVATION A

FLOOR LEVEL

E6HS0001	E6HS0011	E6HS0021	E6HS0031	E6HS0041	E6HS0051	E6HS0061	E6HS0071	E6HS0081	E6HS0091	E6HS0101	E6HS0111	E6HS0121	E6HS0131	E6HS0141	E6HS0151	E6HS0161	E6HS0171	E6HS0181	E6HS0191	E6HS0201	E6HS0211	E6HS0221	E6HS0231	E6HS0241	E6HS0251	E6HS0261	E6HS0271	E6HS0281	E6HS0291	E6HS0301	E6HS0311	E6HS0321
E6HS0002	E6HS0012	E6HS0022	E6HS0032	E6HS0042	E6HS0052	E6HS0062	E6HS0072	E6HS0082	E6HS0092	E6HS0102	E6HS0112	E6HS0122	E6HS0132	E6HS0142	E6HS0152	E6HS0162	E6HS0172	E6HS0182	E6HS0192	E6HS0202	E6HS0212	E6HS0222	E6HS0232	E6HS0242	E6HS0252	E6HS0262	E6HS0272	E6HS0282	E6HS0292	E6HS0302	E6HS0312	E6HS0322
E6HS0003	E6HS0013	E6HS0023	E6HS0033	E6HS0043	E6HS0053	E6HS0063	E6HS0073	E6HS0083	E6HS0093	E6HS0103	E6HS0113	E6HS0123	E6HS0133	E6HS0143	E6HS0153	E6HS0163	E6HS0173	E6HS0183	E6HS0193	E6HS0203	E6HS0213	E6HS0223	E6HS0233	E6HS0243	E6HS0253	E6HS0263	E6HS0273	E6HS0283	E6HS0293	E6HS0303	E6HS0313	E6HS0323
E6HS0004	E6HS0014	E6HS0024	E6HS0034	E6HS0044	E6HS0054	E6HS0064	E6HS0074	E6HS0084	E6HS0094	E6HS0104	E6HS0114	E6HS0124	E6HS0134	E6HS0144	E6HS0154	E6HS0164	E6HS0174	E6HS0184	E6HS0194	E6HS0204	E6HS0214	E6HS0224	E6HS0234	E6HS0244	E6HS0254	E6HS0264	E6HS0274	E6HS0284	E6HS0294	E6HS0304	E6HS0314	E6HS0324
E6HS0005	E6HS0015	E6HS0025	E6HS0035	E6HS0045	E6HS0055	E6HS0065	E6HS0075	E6HS0085	E6HS0095	E6HS0105	E6HS0115	E6HS0125	E6HS0135	E6HS0145	E6HS0155	E6HS0165	E6HS0175	E6HS0185	E6HS0195	E6HS0205	E6HS0215	E6HS0225	E6HS0235	E6HS0245	E6HS0255	E6HS0265	E6HS0275	E6HS0285	E6HS0295	E6HS0305	E6HS0315	E6HS0325
E6HS0006	E6HS0016	E6HS0026	E6HS0036	E6HS0046	E6HS0056	E6HS0066	E6HS0076	E6HS0086	E6HS0096	E6HS0106	E6HS0116	E6HS0126	E6HS0136	E6HS0146	E6HS0156	E6HS0166	E6HS0176	E6HS0186	E6HS0196	E6HS0206	E6HS0216	E6HS0226	E6HS0236	E6HS0246	E6HS0256	E6HS0266	E6HS0276	E6HS0286	E6HS0296	E6HS0306	E6HS0316	E6HS0326
E6HS0007	E6HS0017	E6HS0027	E6HS0037	E6HS0047	E6HS0057	E6HS0067	E6HS0077	E6HS0087	E6HS0097	E6HS0107	E6HS0117	E6HS0127	E6HS0137	E6HS0147	E6HS0157	E6HS0167	E6HS0177	E6HS0187	E6HS0197	E6HS0207	E6HS0217	E6HS0227	E6HS0237	E6HS0247	E6HS0257	E6HS0267	E6HS0277	E6HS0287	E6HS0297	E6HS0307	E6HS0317	E6HS0327
E6HS0008	E6HS0018	E6HS0028	E6HS0038	E6HS0048	E6HS0058	E6HS0068	E6HS0078	E6HS0088	E6HS0098	E6HS0108	E6HS0118	E6HS0128	E6HS0138	E6HS0148	E6HS0158	E6HS0168	E6HS0178	E6HS0188	E6HS0198	E6HS0208	E6HS0218	E6HS0228	E6HS0238	E6HS0248	E6HS0258	E6HS0268	E6HS0278	E6HS0288	E6HS0298	E6HS0308	E6HS0318	E6HS0328
E6HS0009	E6HS0019	E6HS0029	E6HS0039	E6HS0049	E6HS0059	E6HS0069	E6HS0079	E6HS0089	E6HS0099	E6HS0109	E6HS0119	E6HS0129	E6HS0139	E6HS0149	E6HS0159	E6HS0169	E6HS0179	E6HS0189	E6HS0199	E6HS0209	E6HS0219	E6HS0229	E6HS0239	E6HS0249	E6HS0259	E6HS0269	E6HS0279	E6HS0289	E6HS0299	E6HS0309	E6HS0319	E6HS0329
E6HS0010	E6HS0020	E6HS0030	E6HS0040	E6HS0050	E6HS0060	E6HS0070	E6HS0080	E6HS0090	E6HS0100	E6HS0110	E6HS0120	E6HS0130	E6HS0140	E6HS0150	E6HS0160	E6HS0170	E6HS0180	E6HS0190	E6HS0200	E6HS0210	E6HS0220	E6HS0230	E6HS0240	E6HS0250	E6HS0260	E6HS0270	E6HS0280	E6HS0290	E6HS0300	E6HS0310	E6HS0320	E6HS0330

25 TYP. 200 TYP. 25 TYP.

20 TYP. 210 TYP. 20 TYP.

E6HS0001 ~ E6HS0330  
6/F ELEVATION A

25 TYP. 200 TYP. 25 TYP.

20 TYP. 210 TYP. 20 TYP.

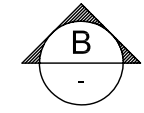
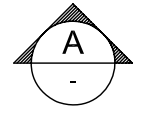
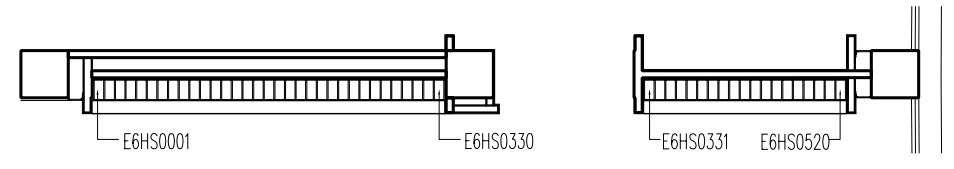

6/F FLOOR PLAN

FLOOR LEVEL

E6HS0331	E6HS0341	E6HS0351	E6HS0361	E6HS0371	E6HS0381	E6HS0391	E6HS0401	E6HS0411	E6HS0421	E6HS0431	E6HS0441	E6HS0451	E6HS0461	E6HS0471	E6HS0481	E6HS0491	E6HS0501	E6HS0511
E6HS0332	E6HS0342	E6HS0352	E6HS0362	E6HS0372	E6HS0382	E6HS0392	E6HS0402	E6HS0412	E6HS0422	E6HS0432	E6HS0442	E6HS0452	E6HS0462	E6HS0472	E6HS0482	E6HS0492	E6HS0502	E6HS0512
E6HS0333	E6HS0343	E6HS0353	E6HS0363	E6HS0373	E6HS0383	E6HS0393	E6HS0403	E6HS0413	E6HS0423	E6HS0433	E6HS0443	E6HS0453	E6HS0463	E6HS0473	E6HS0483	E6HS0493	E6HS0503	E6HS0513
E6HS0334	E6HS0344	E6HS0354	E6HS0364	E6HS0374	E6HS0384	E6HS0394	E6HS0404	E6HS0414	E6HS0424	E6HS0434	E6HS0444	E6HS0454	E6HS0464	E6HS0474	E6HS0484	E6HS0494	E6HS0504	E6HS0514
E6HS0335	E6HS0345	E6HS0355	E6HS0365	E6HS0375	E6HS0385	E6HS0395	E6HS0405	E6HS0415	E6HS0425	E6HS0435	E6HS0445	E6HS0455	E6HS0465	E6HS0475	E6HS0485	E6HS0495	E6HS0505	E6HS0515
E6HS0336	E6HS0346	E6HS0356	E6HS0366	E6HS0376	E6HS0386	E6HS0396	E6HS0406	E6HS0416	E6HS0426	E6HS0436	E6HS0446	E6HS0456	E6HS0466	E6HS0476	E6HS0486	E6HS0496	E6HS0506	E6HS0516
E6HS0337	E6HS0347	E6HS0357	E6HS0367	E6HS0377	E6HS0387	E6HS0397	E6HS0407	E6HS0417	E6HS0427	E6HS0437	E6HS0447	E6HS0457	E6HS0467	E6HS0477	E6HS0487	E6HS0497	E6HS0507	E6HS0517
E6HS0338	E6HS0348	E6HS0358	E6HS0368	E6HS0378	E6HS0388	E6HS0398	E6HS0408	E6HS0418	E6HS0428	E6HS0438	E6HS0448	E6HS0458	E6HS0468	E6HS0478	E6HS0488	E6HS0498	E6HS0508	E6HS0518
E6HS0339	E6HS0349	E6HS0359	E6HS0369	E6HS0379	E6HS0389	E6HS0399	E6HS0409	E6HS0419	E6HS0429	E6HS0439	E6HS0449	E6HS0459	E6HS0469	E6HS0479	E6HS0489	E6HS0499	E6HS0509	E6HS0519
E6HS0340	E6HS0350	E6HS0360	E6HS0370	E6HS0380	E6HS0390	E6HS0400	E6HS0410	E6HS0420	E6HS0430	E6HS0440	E6HS0450	E6HS0460	E6HS0470	E6HS0480	E6HS0490	E6HS0500	E6HS0510	E6HS0520

E6HS0331 ~ E6HS0520  
6/F ELEVATION B

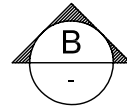
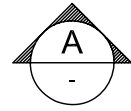
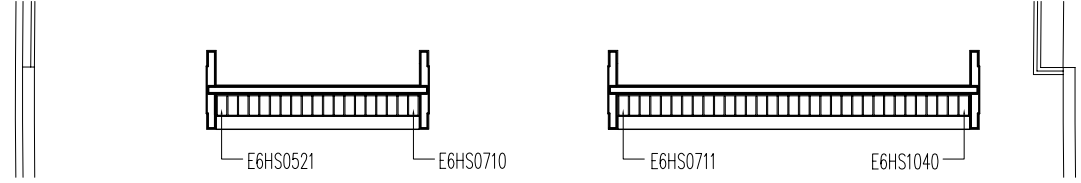

6/F FLOOR PLAN

FLOOR LEVEL

E6HS0521	E6HS0531	E6HS0541	E6HS0551	E6HS0561	E6HS0571	E6HS0581	E6HS0591	E6HS0601	E6HS0611	E6HS0621	E6HS0631	E6HS0641	E6HS0651	E6HS0661	E6HS0671	E6HS0681	E6HS0691	E6HS0701
E6HS0522	E6HS0532	E6HS0542	E6HS0552	E6HS0562	E6HS0572	E6HS0582	E6HS0592	E6HS0602	E6HS0612	E6HS0622	E6HS0632	E6HS0642	E6HS0652	E6HS0662	E6HS0672	E6HS0682	E6HS0692	E6HS0702
E6HS0523	E6HS0533	E6HS0543	E6HS0553	E6HS0563	E6HS0573	E6HS0583	E6HS0593	E6HS0603	E6HS0613	E6HS0623	E6HS0633	E6HS0643	E6HS0653	E6HS0663	E6HS0673	E6HS0683	E6HS0693	E6HS0703
E6HS0524	E6HS0534	E6HS0544	E6HS0554	E6HS0564	E6HS0574	E6HS0584	E6HS0594	E6HS0604	E6HS0614	E6HS0624	E6HS0634	E6HS0644	E6HS0654	E6HS0664	E6HS0674	E6HS0684	E6HS0694	E6HS0704
E6HS0525	E6HS0535	E6HS0545	E6HS0555	E6HS0565	E6HS0575	E6HS0585	E6HS0595	E6HS0605	E6HS0615	E6HS0625	E6HS0635	E6HS0645	E6HS0655	E6HS0665	E6HS0675	E6HS0685	E6HS0695	E6HS0705
E6HS0526	E6HS0536	E6HS0546	E6HS0556	E6HS0566	E6HS0576	E6HS0586	E6HS0596	E6HS0606	E6HS0616	E6HS0626	E6HS0636	E6HS0646	E6HS0656	E6HS0666	E6HS0676	E6HS0686	E6HS0696	E6HS0706
E6HS0527	E6HS0537	E6HS0547	E6HS0557	E6HS0567	E6HS0577	E6HS0587	E6HS0597	E6HS0607	E6HS0617	E6HS0627	E6HS0637	E6HS0647	E6HS0657	E6HS0667	E6HS0677	E6HS0687	E6HS0697	E6HS0707
E6HS0528	E6HS0538	E6HS0548	E6HS0558	E6HS0568	E6HS0578	E6HS0588	E6HS0598	E6HS0608	E6HS0618	E6HS0628	E6HS0638	E6HS0648	E6HS0658	E6HS0668	E6HS0678	E6HS0688	E6HS0698	E6HS0708
E6HS0529	E6HS0539	E6HS0549	E6HS0559	E6HS0569	E6HS0579	E6HS0589	E6HS0599	E6HS0609	E6HS0619	E6HS0629	E6HS0639	E6HS0649	E6HS0659	E6HS0669	E6HS0679	E6HS0689	E6HS0699	E6HS0709
E6HS0530	E6HS0540	E6HS0550	E6HS0560	E6HS0570	E6HS0580	E6HS0590	E6HS0600	E6HS0610	E6HS0620	E6HS0630	E6HS0640	E6HS0650	E6HS0660	E6HS0670	E6HS0680	E6HS0690	E6HS0700	E6HS0710

25 TYP. 200 TYP. 25 TYP.

20 TYP. 210 TYP. 20 TYP.

E6HS0521 ~ E6HS0710  
6/F ELEVATION A

25 TYP. 200 TYP. 25 TYP.

FLOOR LEVEL

E6HS0711	E6HS0721	E6HS0731	E6HS0741	E6HS0751	E6HS0761	E6HS0771	E6HS0781	E6HS0791	E6HS0801	E6HS0811	E6HS0821	E6HS0831	E6HS0841	E6HS0851	E6HS0861	E6HS0871	E6HS0881	E6HS0891	E6HS0901	E6HS0911	E6HS0921	E6HS0931	E6HS0941	E6HS0951	E6HS0961	E6HS0971	E6HS0981	E6HS0991	E6HS1001	E6HS1011	E6HS1021	E6HS1031
E6HS0712	E6HS0722	E6HS0732	E6HS0742	E6HS0752	E6HS0762	E6HS0772	E6HS0782	E6HS0792	E6HS0802	E6HS0812	E6HS0822	E6HS0832	E6HS0842	E6HS0852	E6HS0862	E6HS0872	E6HS0882	E6HS0892	E6HS0902	E6HS0912	E6HS0922	E6HS0932	E6HS0942	E6HS0952	E6HS0962	E6HS0972	E6HS0982	E6HS0992	E6HS1002	E6HS1012	E6HS1022	E6HS1032
E6HS0713	E6HS0723	E6HS0733	E6HS0743	E6HS0753	E6HS0763	E6HS0773	E6HS0783	E6HS0793	E6HS0803	E6HS0813	E6HS0823	E6HS0833	E6HS0843	E6HS0853	E6HS0863	E6HS0873	E6HS0883	E6HS0893	E6HS0903	E6HS0913	E6HS0923	E6HS0933	E6HS0943	E6HS0953	E6HS0963	E6HS0973	E6HS0983	E6HS0993	E6HS1003	E6HS1013	E6HS1023	E6HS1033
E6HS0714	E6HS0724	E6HS0734	E6HS0744	E6HS0754	E6HS0764	E6HS0774	E6HS0784	E6HS0794	E6HS0804	E6HS0814	E6HS0824	E6HS0834	E6HS0844	E6HS0854	E6HS0864	E6HS0874	E6HS0884	E6HS0894	E6HS0904	E6HS0914	E6HS0924	E6HS0934	E6HS0944	E6HS0954	E6HS0964	E6HS0974	E6HS0984	E6HS0994	E6HS1004	E6HS1014	E6HS1024	E6HS1034
E6HS0715	E6HS0725	E6HS0735	E6HS0745	E6HS0755	E6HS0765	E6HS0775	E6HS0785	E6HS0795	E6HS0805	E6HS0815	E6HS0825	E6HS0835	E6HS0845	E6HS0855	E6HS0865	E6HS0875	E6HS0885	E6HS0895	E6HS0905	E6HS0915	E6HS0925	E6HS0935	E6HS0945	E6HS0955	E6HS0965	E6HS0975	E6HS0985	E6HS0995	E6HS1005	E6HS1015	E6HS1025	E6HS1035
E6HS0716	E6HS0726	E6HS0736	E6HS0746	E6HS0756	E6HS0766	E6HS0776	E6HS0786	E6HS0796	E6HS0806	E6HS0816	E6HS0826	E6HS0836	E6HS0846	E6HS0856	E6HS0866	E6HS0876	E6HS0886	E6HS0896	E6HS0906	E6HS0916	E6HS0926	E6HS0936	E6HS0946	E6HS0956	E6HS0966	E6HS0976	E6HS0986	E6HS0996	E6HS1006	E6HS1016	E6HS1026	E6HS1036
E6HS0717	E6HS0727	E6HS0737	E6HS0747	E6HS0757	E6HS0767	E6HS0777	E6HS0787	E6HS0797	E6HS0807	E6HS0817	E6HS0827	E6HS0837	E6HS0847	E6HS0857	E6HS0867	E6HS0877	E6HS0887	E6HS0897	E6HS0907	E6HS0917	E6HS0927	E6HS0937	E6HS0947	E6HS0957	E6HS0967	E6HS0977	E6HS0987	E6HS0997	E6HS1007	E6HS1017	E6HS1027	E6HS1037
E6HS0718	E6HS0728	E6HS0738	E6HS0748	E6HS0758	E6HS0768	E6HS0778	E6HS0788	E6HS0798	E6HS0808	E6HS0818	E6HS0828	E6HS0838	E6HS0848	E6HS0858	E6HS0868	E6HS0878	E6HS0888	E6HS0898	E6HS0908	E6HS0918	E6HS0928	E6HS0938	E6HS0948	E6HS0958	E6HS0968	E6HS0978	E6HS0988	E6HS0998	E6HS1008	E6HS1018	E6HS1028	E6HS1038
E6HS0719	E6HS0729	E6HS0739	E6HS0749	E6HS0759	E6HS0769	E6HS0779	E6HS0789	E6HS0799	E6HS0809	E6HS0819	E6HS0829	E6HS0839	E6HS0849	E6HS0859	E6HS0869	E6HS0879	E6HS0889	E6HS0899	E6HS0909	E6HS0919	E6HS0929	E6HS0939	E6HS0949	E6HS0959	E6HS0969	E6HS0979	E6HS0989	E6HS0999	E6HS1009	E6HS1019	E6HS1029	E6HS1039
E6HS0720	E6HS0730	E6HS0740	E6HS0750	E6HS0760	E6HS0770	E6HS0780	E6HS0790	E6HS0800	E6HS0810	E6HS0820	E6HS0830	E6HS0840	E6HS0850	E6HS0860	E6HS0870	E6HS0880	E6HS0890	E6HS0900	E6HS0910	E6HS0920	E6HS0930	E6HS0940	E6HS0950	E6HS0960	E6HS0970	E6HS0980	E6HS0990	E6HS1000	E6HS1010	E6HS1020	E6HS1030	E6HS1040

20 TYP. 210 TYP. 20 TYP.

E6HS0711 ~ E6HS1040  
6/F ELEVATION B





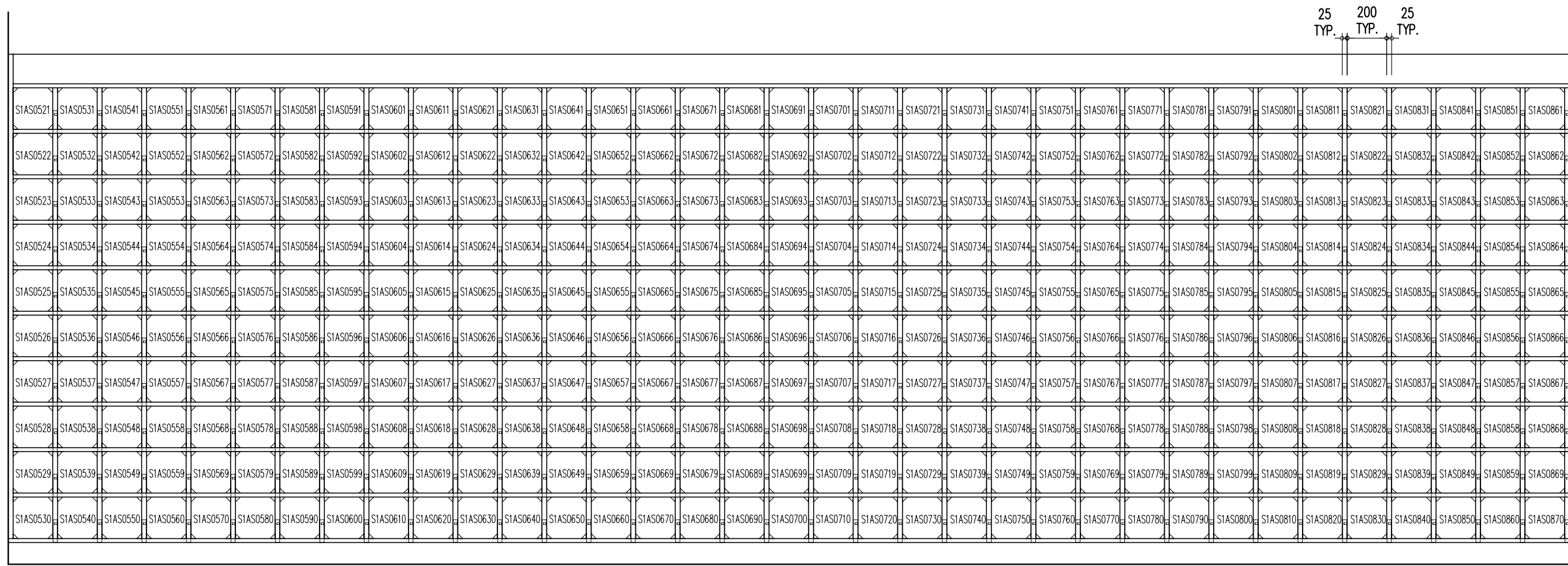

FLOOR LEVEL

S1AS0521 ~ S1AS0870  
1/F ELEVATION A

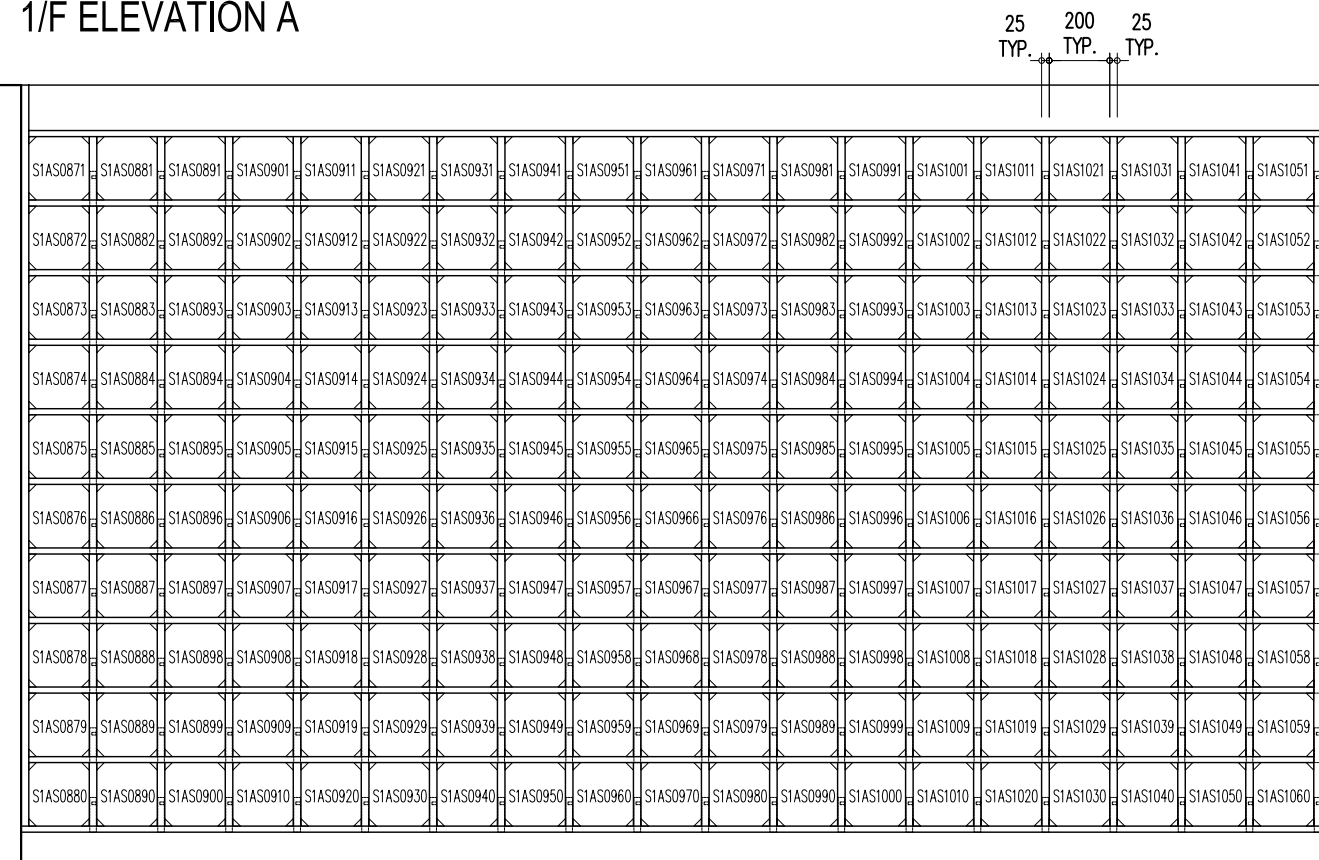

FLOOR LEVEL

S1AS0871 ~ S1AS1060  
1/F ELEVATION B

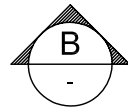
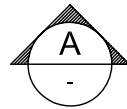
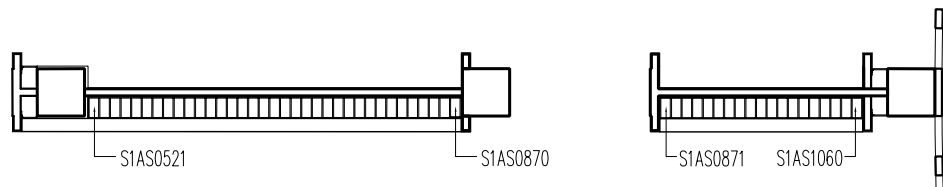

1/F FLOOR PLAN

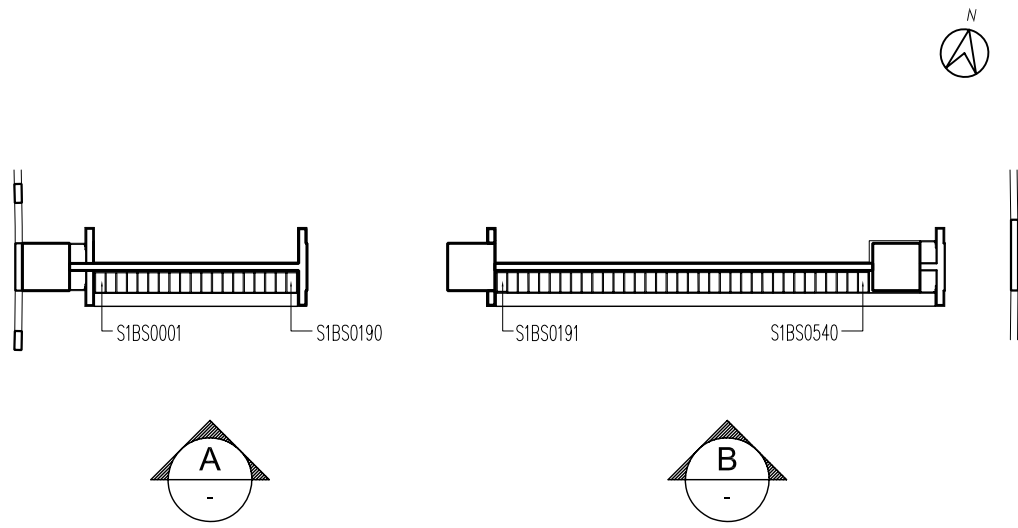

1/F FLOOR PLAN

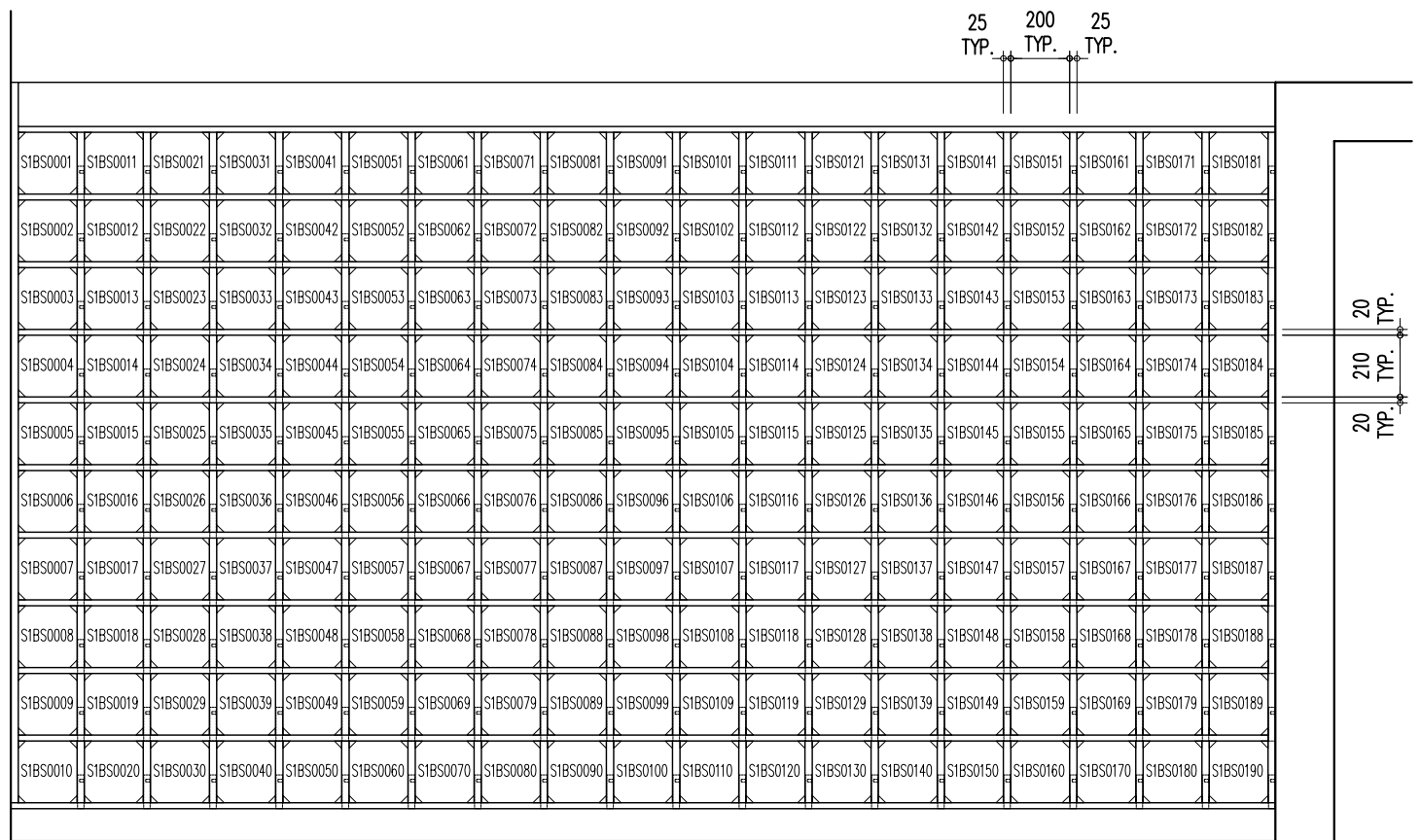

FLOOR LEVEL

S1BS0001 ~ S1BS0190  
1/F ELEVATION A

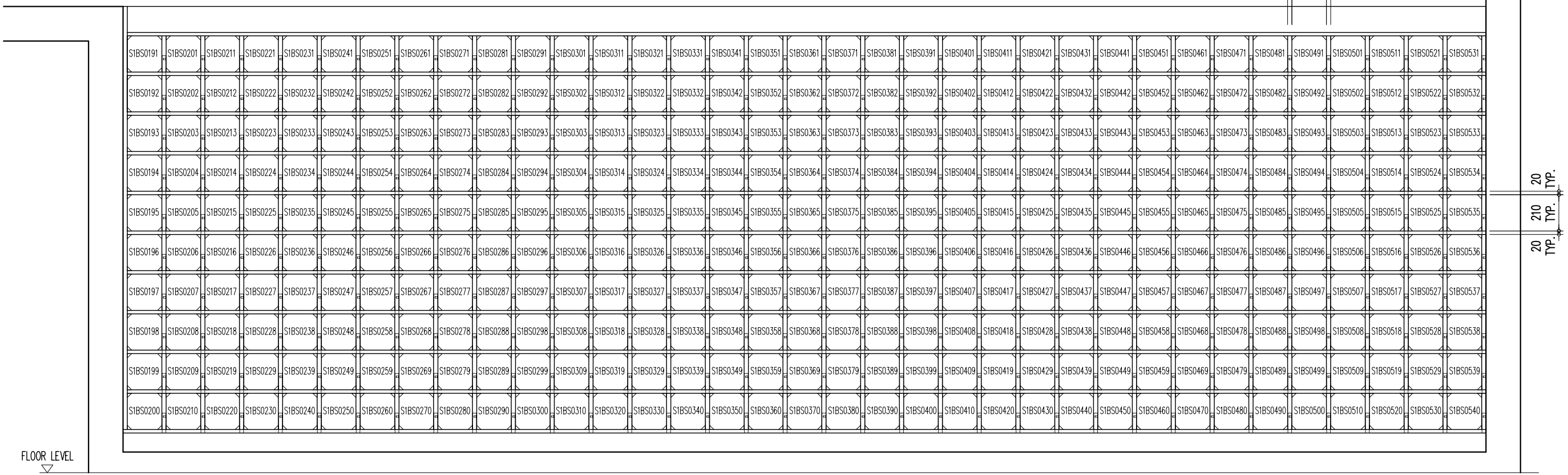

FLOOR LEVEL

S1BS0191 ~ S1BS0540  
1/F ELEVATION B

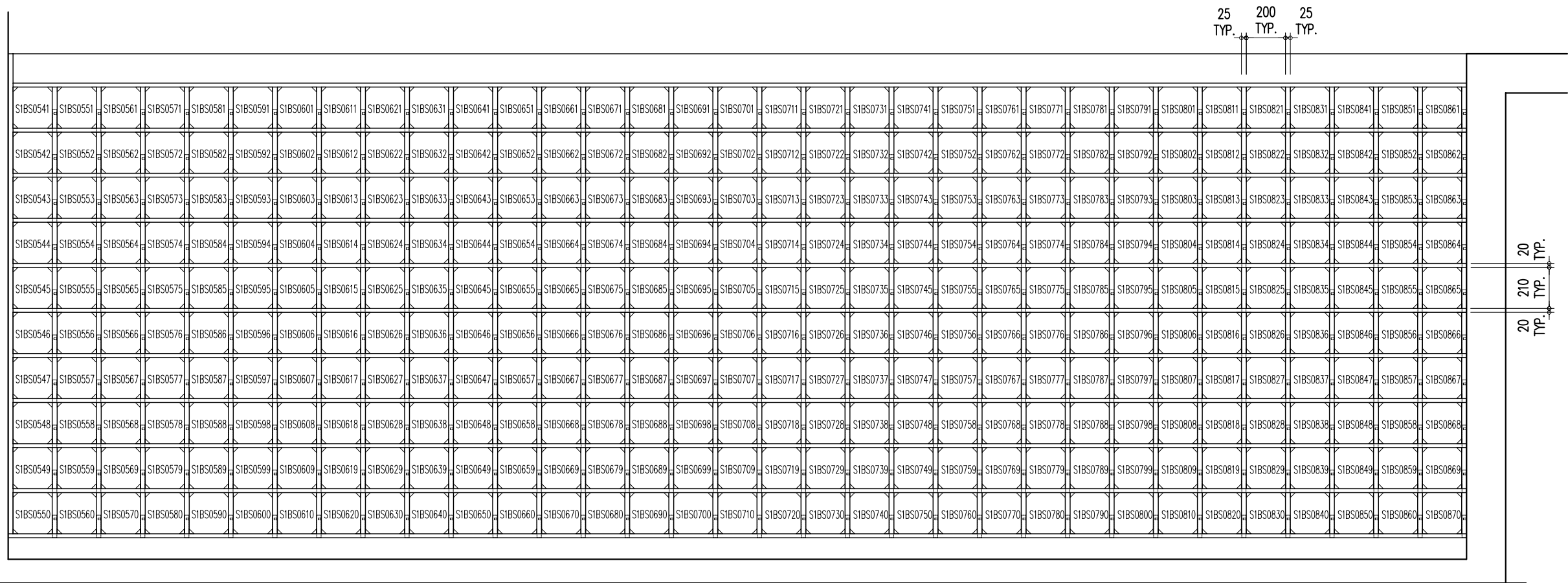

SIBS0541 ~ SIBS0870  
1/F ELEVATION A

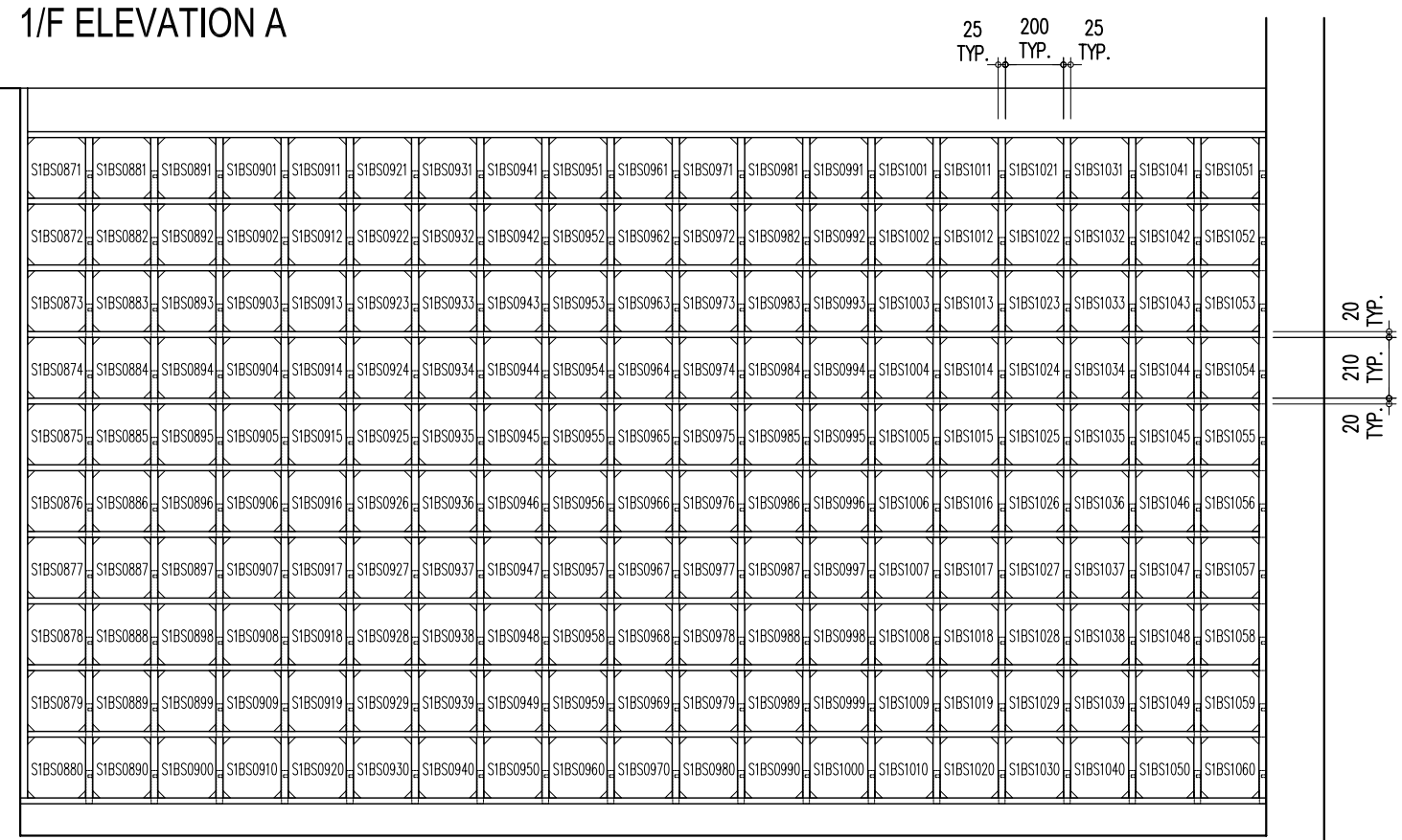

SIBS0871 ~ SIBS1060  
1/F ELEVATION B

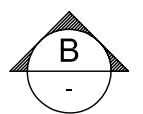
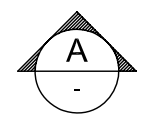
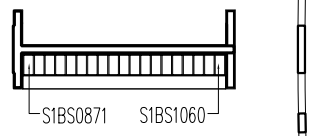
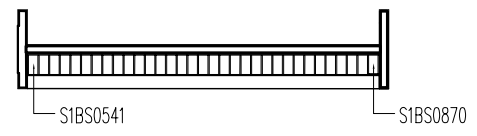

1/F FLOOR PLAN

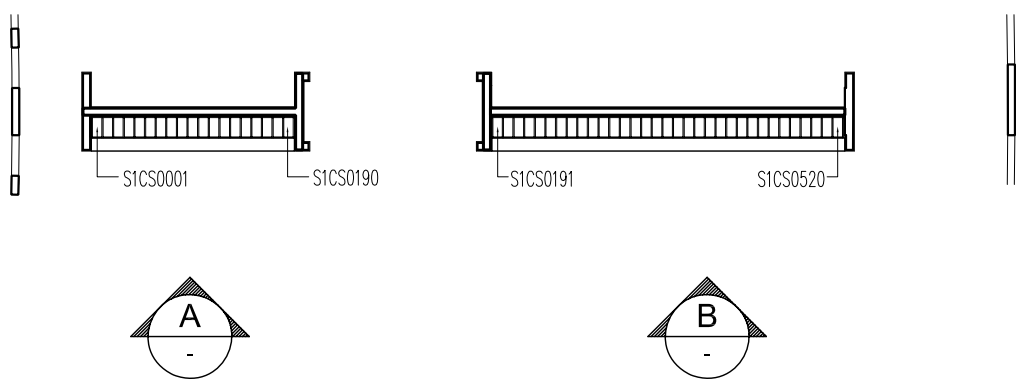

1/F FLOOR PLAN

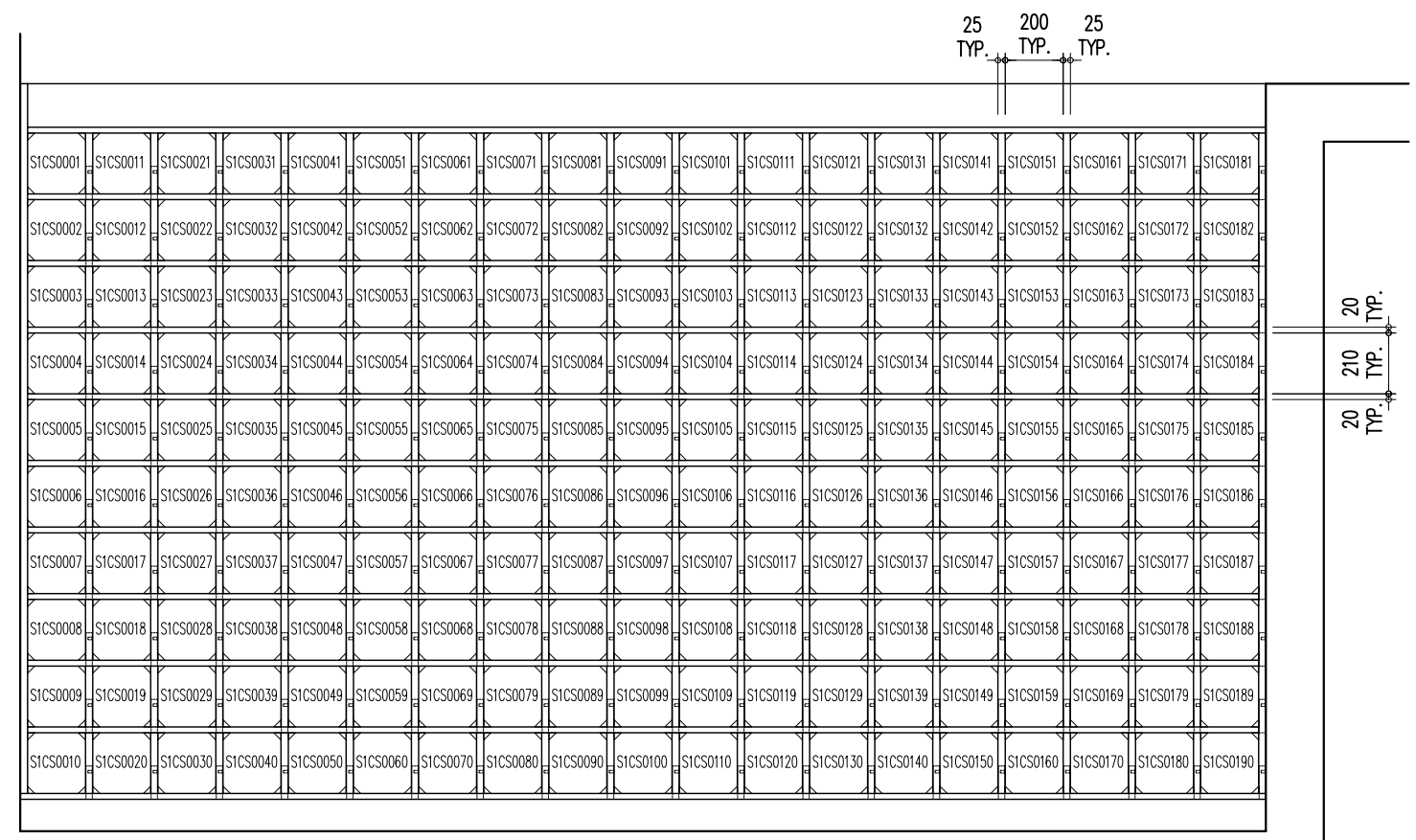

S1CS0001 ~ S1CS0190  
1/F ELEVATION A

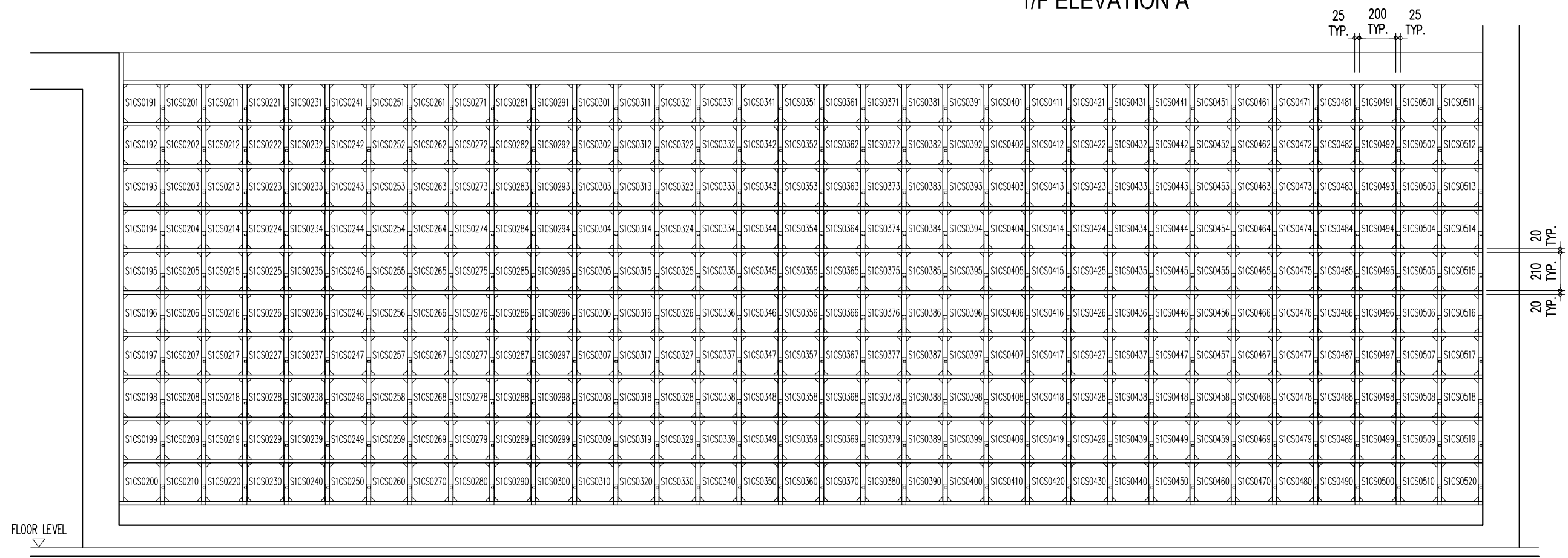

S1CS0191 ~ S1CS0520  
1/F ELEVATION B

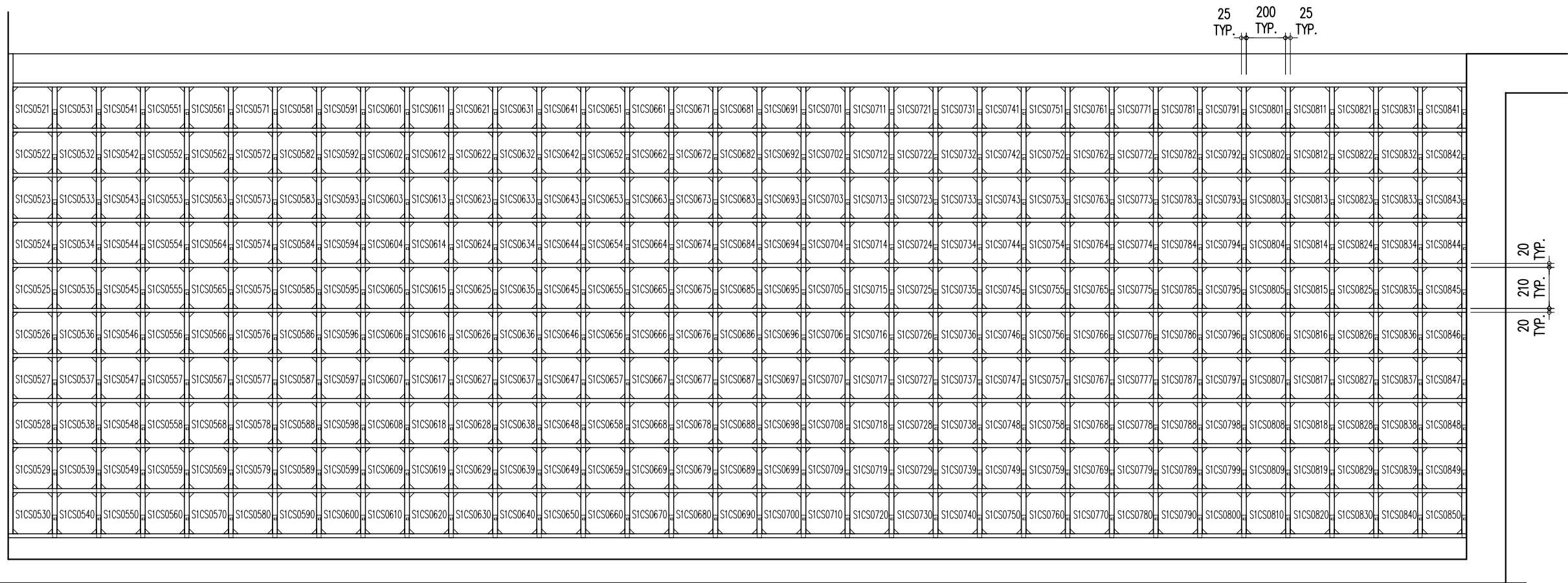

S1CS0521 ~ S1CS0850  
1/F ELEVATION A

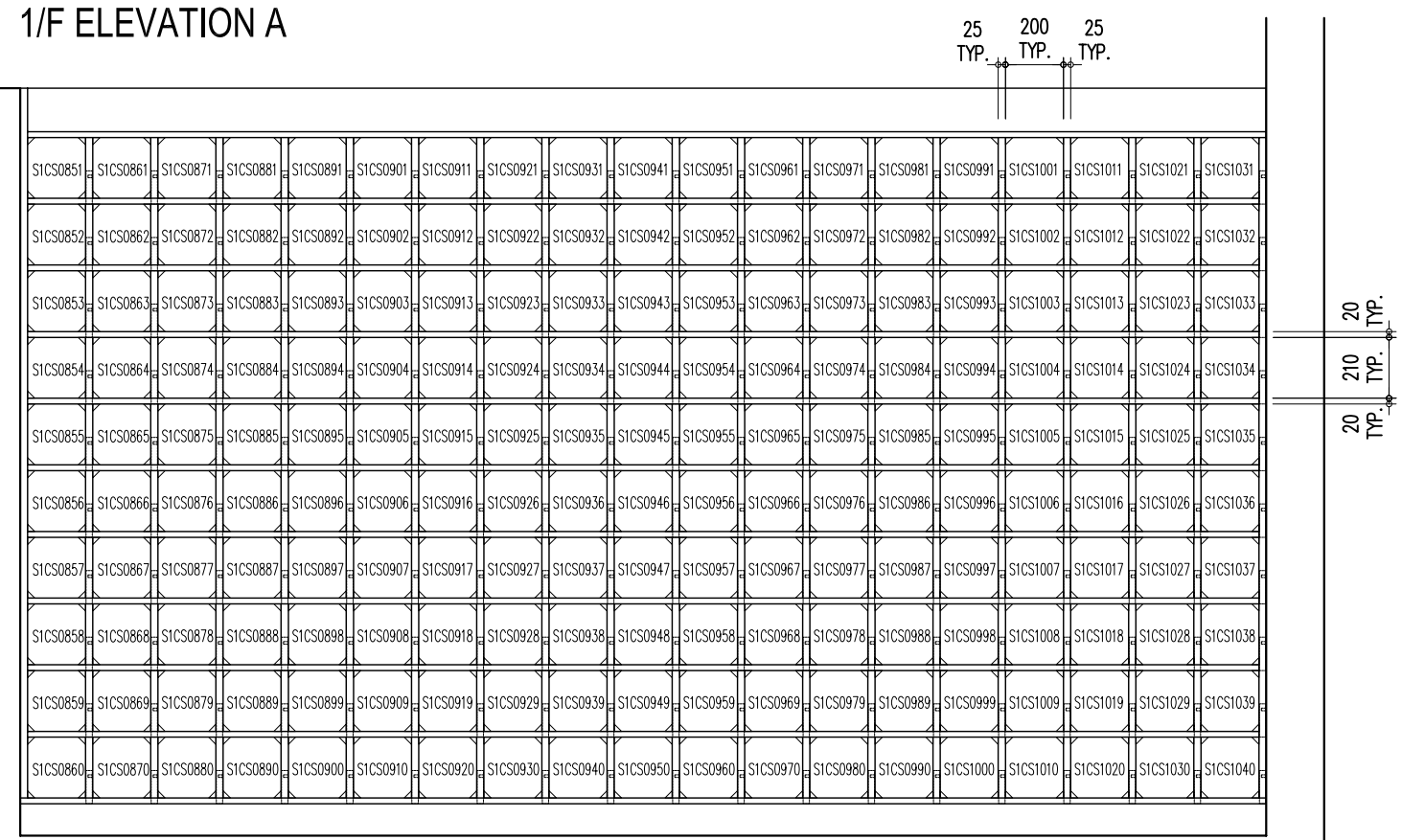

S1CS0851 ~ S1CS1040  
1/F ELEVATION B

FLOOR LEVEL

FLOOR LEVEL

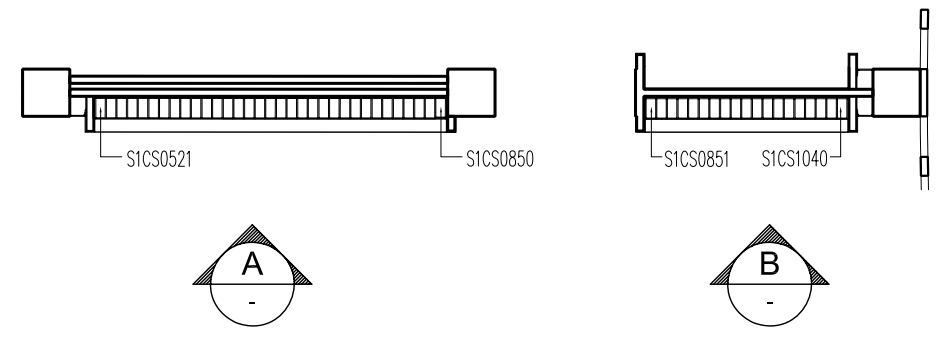
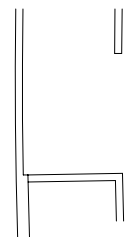

1/F FLOOR PLAN

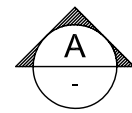
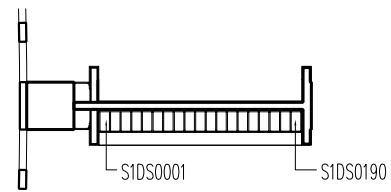

1/F FLOOR PLAN



FLOOR LEVEL  
▽

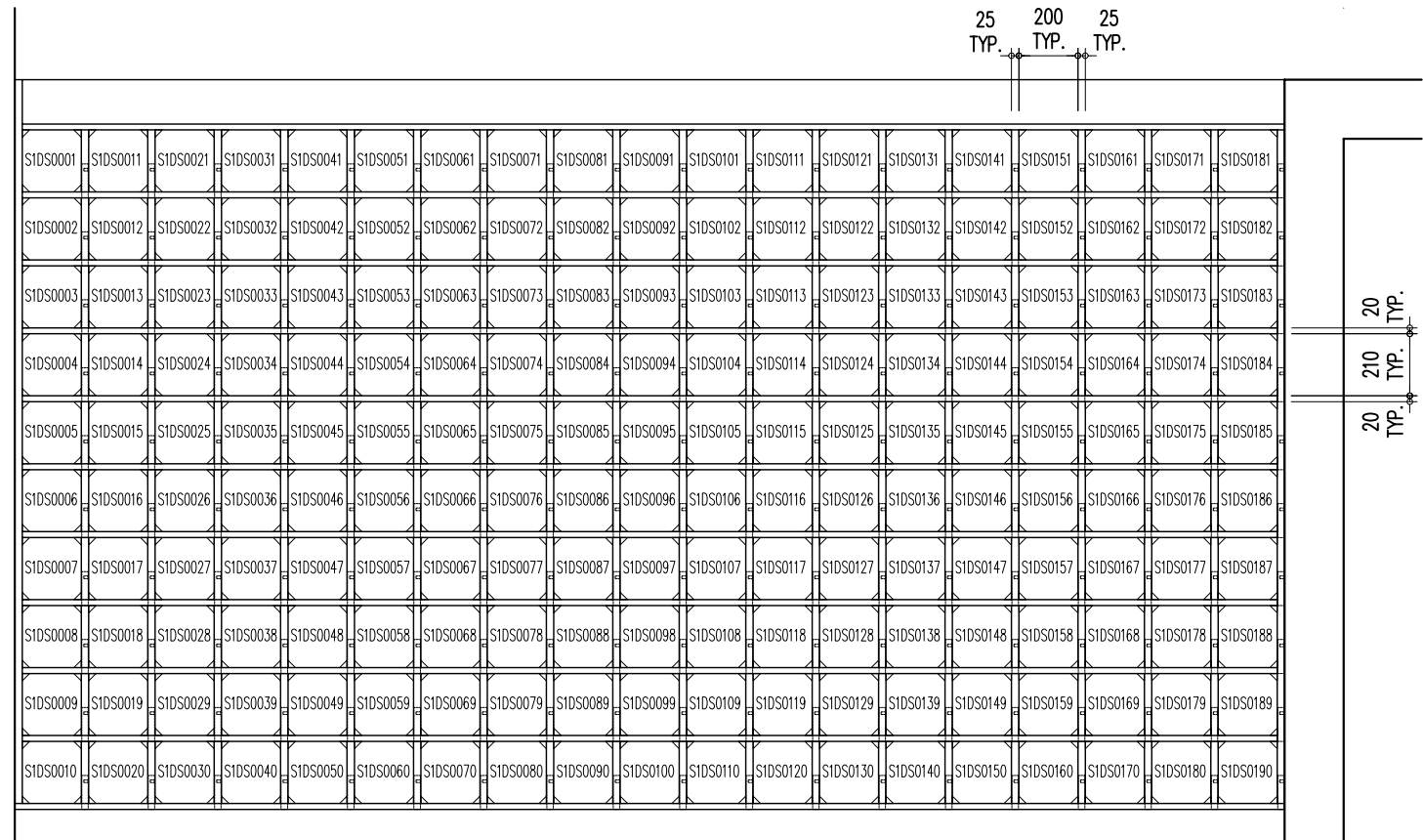

S1DS0001 ~ S1DS0190  
1/F ELEVATION A

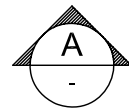
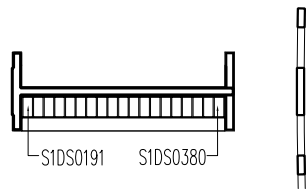

1/F FLOOR PLAN

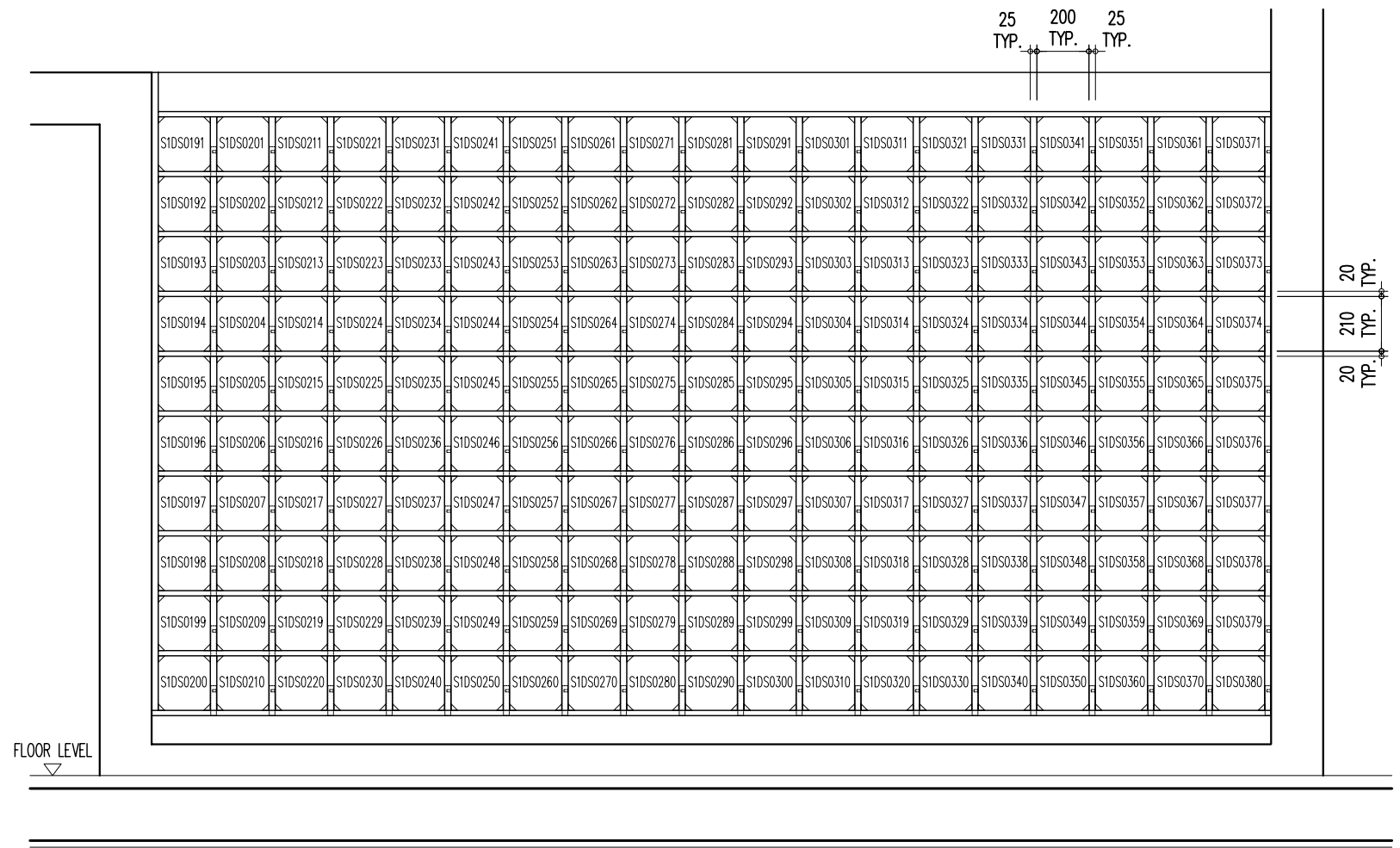

S1DS0191 ~ S1DS0380  
1/F ELEVATION A



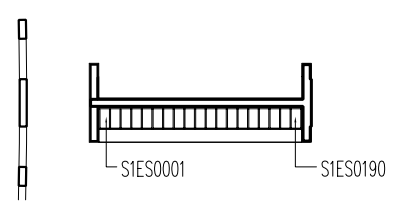

1/F FLOOR PLAN

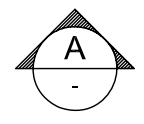

FLOOR LEVEL  
▽

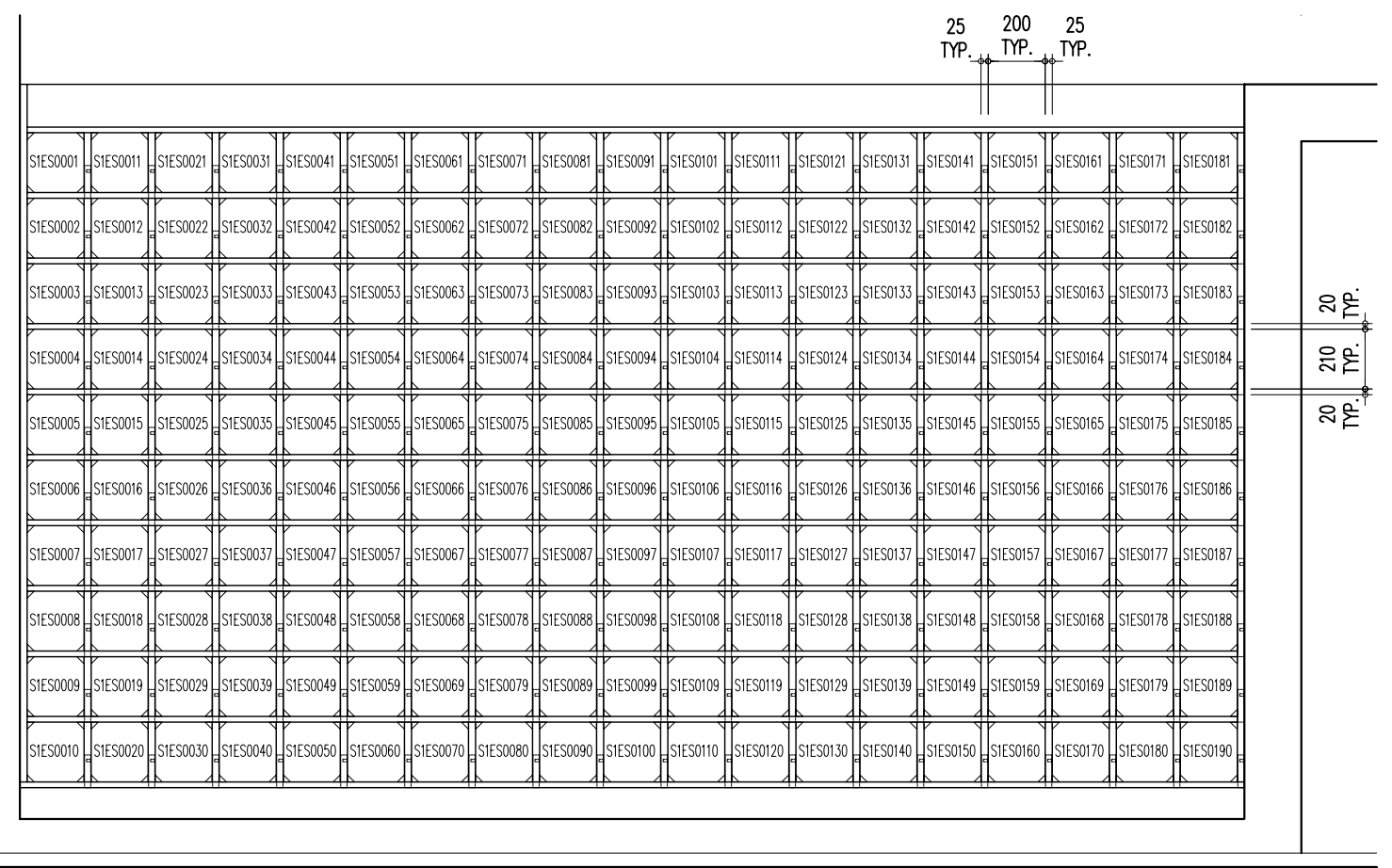

S1ES0001 ~ S1ES0190  
1/F ELEVATION A

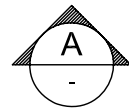
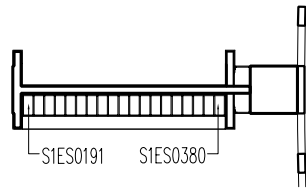

1/F FLOOR PLAN

FLOOR LEVEL  
▽

S1ES0191	S1ES0201	S1ES0211	S1ES0221	S1ES0231	S1ES0241	S1ES0251	S1ES0261	S1ES0271	S1ES0281	S1ES0291	S1ES0301	S1ES0311	S1ES0321	S1ES0331	S1ES0341	S1ES0351	S1ES0361	S1ES0371
S1ES0192	S1ES0202	S1ES0212	S1ES0222	S1ES0232	S1ES0242	S1ES0252	S1ES0262	S1ES0272	S1ES0282	S1ES0292	S1ES0302	S1ES0312	S1ES0322	S1ES0332	S1ES0342	S1ES0352	S1ES0362	S1ES0372
S1ES0193	S1ES0203	S1ES0213	S1ES0223	S1ES0233	S1ES0243	S1ES0253	S1ES0263	S1ES0273	S1ES0283	S1ES0293	S1ES0303	S1ES0313	S1ES0323	S1ES0333	S1ES0343	S1ES0353	S1ES0363	S1ES0373
S1ES0194	S1ES0204	S1ES0214	S1ES0224	S1ES0234	S1ES0244	S1ES0254	S1ES0264	S1ES0274	S1ES0284	S1ES0294	S1ES0304	S1ES0314	S1ES0324	S1ES0334	S1ES0344	S1ES0354	S1ES0364	S1ES0374
S1ES0195	S1ES0205	S1ES0215	S1ES0225	S1ES0235	S1ES0245	S1ES0255	S1ES0265	S1ES0275	S1ES0285	S1ES0295	S1ES0305	S1ES0315	S1ES0325	S1ES0335	S1ES0345	S1ES0355	S1ES0365	S1ES0375
S1ES0196	S1ES0206	S1ES0216	S1ES0226	S1ES0236	S1ES0246	S1ES0256	S1ES0266	S1ES0276	S1ES0286	S1ES0296	S1ES0306	S1ES0316	S1ES0326	S1ES0336	S1ES0346	S1ES0356	S1ES0366	S1ES0376
S1ES0197	S1ES0207	S1ES0217	S1ES0227	S1ES0237	S1ES0247	S1ES0257	S1ES0267	S1ES0277	S1ES0287	S1ES0297	S1ES0307	S1ES0317	S1ES0327	S1ES0337	S1ES0347	S1ES0357	S1ES0367	S1ES0377
S1ES0198	S1ES0208	S1ES0218	S1ES0228	S1ES0238	S1ES0248	S1ES0258	S1ES0268	S1ES0278	S1ES0288	S1ES0298	S1ES0308	S1ES0318	S1ES0328	S1ES0338	S1ES0348	S1ES0358	S1ES0368	S1ES0378
S1ES0199	S1ES0209	S1ES0219	S1ES0229	S1ES0239	S1ES0249	S1ES0259	S1ES0269	S1ES0279	S1ES0289	S1ES0299	S1ES0309	S1ES0319	S1ES0329	S1ES0339	S1ES0349	S1ES0359	S1ES0369	S1ES0379
S1ES0200	S1ES0210	S1ES0220	S1ES0230	S1ES0240	S1ES0250	S1ES0260	S1ES0270	S1ES0280	S1ES0290	S1ES0300	S1ES0310	S1ES0320	S1ES0330	S1ES0340	S1ES0350	S1ES0360	S1ES0370	S1ES0380

25 TYP.  
200 TYP.  
25 TYP.

20 TYP.  
210 TYP.  
20 TYP.

S1ES0191 ~ S1ES0380  
1/F ELEVATION A

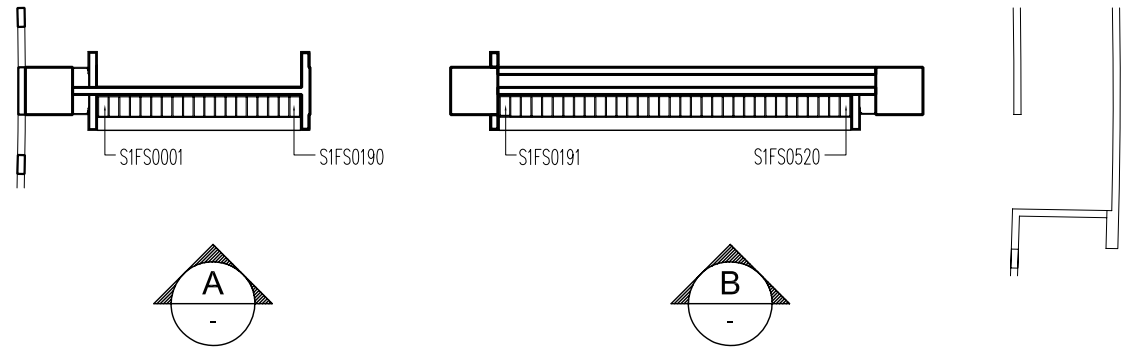

1/F FLOOR PLAN

SIFS0001	SIFS0011	SIFS0021	SIFS0031	SIFS0041	SIFS0051	SIFS0061	SIFS0071	SIFS0081	SIFS0091	SIFS0101	SIFS0111	SIFS0121	SIFS0131	SIFS0141	SIFS0151	SIFS0161	SIFS0171	SIFS0181
SIFS0002	SIFS0012	SIFS0022	SIFS0032	SIFS0042	SIFS0052	SIFS0062	SIFS0072	SIFS0082	SIFS0092	SIFS0102	SIFS0112	SIFS0122	SIFS0132	SIFS0142	SIFS0152	SIFS0162	SIFS0172	SIFS0182
SIFS0003	SIFS0013	SIFS0023	SIFS0033	SIFS0043	SIFS0053	SIFS0063	SIFS0073	SIFS0083	SIFS0093	SIFS0103	SIFS0113	SIFS0123	SIFS0133	SIFS0143	SIFS0153	SIFS0163	SIFS0173	SIFS0183
SIFS0004	SIFS0014	SIFS0024	SIFS0034	SIFS0044	SIFS0054	SIFS0064	SIFS0074	SIFS0084	SIFS0094	SIFS0104	SIFS0114	SIFS0124	SIFS0134	SIFS0144	SIFS0154	SIFS0164	SIFS0174	SIFS0184
SIFS0005	SIFS0015	SIFS0025	SIFS0035	SIFS0045	SIFS0055	SIFS0065	SIFS0075	SIFS0085	SIFS0095	SIFS0105	SIFS0115	SIFS0125	SIFS0135	SIFS0145	SIFS0155	SIFS0165	SIFS0175	SIFS0185
SIFS0006	SIFS0016	SIFS0026	SIFS0036	SIFS0046	SIFS0056	SIFS0066	SIFS0076	SIFS0086	SIFS0096	SIFS0106	SIFS0116	SIFS0126	SIFS0136	SIFS0146	SIFS0156	SIFS0166	SIFS0176	SIFS0186
SIFS0007	SIFS0017	SIFS0027	SIFS0037	SIFS0047	SIFS0057	SIFS0067	SIFS0077	SIFS0087	SIFS0097	SIFS0107	SIFS0117	SIFS0127	SIFS0137	SIFS0147	SIFS0157	SIFS0167	SIFS0177	SIFS0187
SIFS0008	SIFS0018	SIFS0028	SIFS0038	SIFS0048	SIFS0058	SIFS0068	SIFS0078	SIFS0088	SIFS0098	SIFS0108	SIFS0118	SIFS0128	SIFS0138	SIFS0148	SIFS0158	SIFS0168	SIFS0178	SIFS0188
SIFS0009	SIFS0019	SIFS0029	SIFS0039	SIFS0049	SIFS0059	SIFS0069	SIFS0079	SIFS0089	SIFS0099	SIFS0109	SIFS0119	SIFS0129	SIFS0139	SIFS0149	SIFS0159	SIFS0169	SIFS0179	SIFS0189
SIFS0010	SIFS0020	SIFS0030	SIFS0040	SIFS0050	SIFS0060	SIFS0070	SIFS0080	SIFS0090	SIFS0100	SIFS0110	SIFS0120	SIFS0130	SIFS0140	SIFS0150	SIFS0160	SIFS0170	SIFS0180	SIFS0190

25 TYP.    200 TYP.    25 TYP.

20 TYP.    210 TYP.    20 TYP.

FLOOR LEVEL

SIFS0001 ~ SIFS0190  
1/F ELEVATION A

SIFS0191	SIFS0201	SIFS0211	SIFS0221	SIFS0231	SIFS0241	SIFS0251	SIFS0261	SIFS0271	SIFS0281	SIFS0291	SIFS0301	SIFS0311	SIFS0321	SIFS0331	SIFS0341	SIFS0351	SIFS0361	SIFS0371	SIFS0381	SIFS0391	SIFS0401	SIFS0411	SIFS0421	SIFS0431	SIFS0441	SIFS0451	SIFS0461	SIFS0471	SIFS0481	SIFS0491	SIFS0501	SIFS0511
SIFS0192	SIFS0202	SIFS0212	SIFS0222	SIFS0232	SIFS0242	SIFS0252	SIFS0262	SIFS0272	SIFS0282	SIFS0292	SIFS0302	SIFS0312	SIFS0322	SIFS0332	SIFS0342	SIFS0352	SIFS0362	SIFS0372	SIFS0382	SIFS0392	SIFS0402	SIFS0412	SIFS0422	SIFS0432	SIFS0442	SIFS0452	SIFS0462	SIFS0472	SIFS0482	SIFS0492	SIFS0502	SIFS0512
SIFS0193	SIFS0203	SIFS0213	SIFS0223	SIFS0233	SIFS0243	SIFS0253	SIFS0263	SIFS0273	SIFS0283	SIFS0293	SIFS0303	SIFS0313	SIFS0323	SIFS0333	SIFS0343	SIFS0353	SIFS0363	SIFS0373	SIFS0383	SIFS0393	SIFS0403	SIFS0413	SIFS0423	SIFS0433	SIFS0443	SIFS0453	SIFS0463	SIFS0473	SIFS0483	SIFS0493	SIFS0503	SIFS0513
SIFS0194	SIFS0204	SIFS0214	SIFS0224	SIFS0234	SIFS0244	SIFS0254	SIFS0264	SIFS0274	SIFS0284	SIFS0294	SIFS0304	SIFS0314	SIFS0324	SIFS0334	SIFS0344	SIFS0354	SIFS0364	SIFS0374	SIFS0384	SIFS0394	SIFS0404	SIFS0414	SIFS0424	SIFS0434	SIFS0444	SIFS0454	SIFS0464	SIFS0474	SIFS0484	SIFS0494	SIFS0504	SIFS0514
SIFS0195	SIFS0205	SIFS0215	SIFS0225	SIFS0235	SIFS0245	SIFS0255	SIFS0265	SIFS0275	SIFS0285	SIFS0295	SIFS0305	SIFS0315	SIFS0325	SIFS0335	SIFS0345	SIFS0355	SIFS0365	SIFS0375	SIFS0385	SIFS0395	SIFS0405	SIFS0415	SIFS0425	SIFS0435	SIFS0445	SIFS0455	SIFS0465	SIFS0475	SIFS0485	SIFS0495	SIFS0505	SIFS0515
SIFS0196	SIFS0206	SIFS0216	SIFS0226	SIFS0236	SIFS0246	SIFS0256	SIFS0266	SIFS0276	SIFS0286	SIFS0296	SIFS0306	SIFS0316	SIFS0326	SIFS0336	SIFS0346	SIFS0356	SIFS0366	SIFS0376	SIFS0386	SIFS0396	SIFS0406	SIFS0416	SIFS0426	SIFS0436	SIFS0446	SIFS0456	SIFS0466	SIFS0476	SIFS0486	SIFS0496	SIFS0506	SIFS0516
SIFS0197	SIFS0207	SIFS0217	SIFS0227	SIFS0237	SIFS0247	SIFS0257	SIFS0267	SIFS0277	SIFS0287	SIFS0297	SIFS0307	SIFS0317	SIFS0327	SIFS0337	SIFS0347	SIFS0357	SIFS0367	SIFS0377	SIFS0387	SIFS0397	SIFS0407	SIFS0417	SIFS0427	SIFS0437	SIFS0447	SIFS0457	SIFS0467	SIFS0477	SIFS0487	SIFS0497	SIFS0507	SIFS0517
SIFS0198	SIFS0208	SIFS0218	SIFS0228	SIFS0238	SIFS0248	SIFS0258	SIFS0268	SIFS0278	SIFS0288	SIFS0298	SIFS0308	SIFS0318	SIFS0328	SIFS0338	SIFS0348	SIFS0358	SIFS0368	SIFS0378	SIFS0388	SIFS0398	SIFS0408	SIFS0418	SIFS0428	SIFS0438	SIFS0448	SIFS0458	SIFS0468	SIFS0478	SIFS0488	SIFS0498	SIFS0508	SIFS0518
SIFS0199	SIFS0209	SIFS0219	SIFS0229	SIFS0239	SIFS0249	SIFS0259	SIFS0269	SIFS0279	SIFS0289	SIFS0299	SIFS0309	SIFS0319	SIFS0329	SIFS0339	SIFS0349	SIFS0359	SIFS0369	SIFS0379	SIFS0389	SIFS0399	SIFS0409	SIFS0419	SIFS0429	SIFS0439	SIFS0449	SIFS0459	SIFS0469	SIFS0479	SIFS0489	SIFS0499	SIFS0509	SIFS0519
SIFS0200	SIFS0210	SIFS0220	SIFS0230	SIFS0240	SIFS0250	SIFS0260	SIFS0270	SIFS0280	SIFS0290	SIFS0300	SIFS0310	SIFS0320	SIFS0330	SIFS0340	SIFS0350	SIFS0360	SIFS0370	SIFS0380	SIFS0390	SIFS0400	SIFS0410	SIFS0420	SIFS0430	SIFS0440	SIFS0450	SIFS0460	SIFS0470	SIFS0480	SIFS0490	SIFS0500	SIFS0510	SIFS0520

25 TYP.    200 TYP.    25 TYP.

20 TYP.    210 TYP.    20 TYP.

FLOOR LEVEL

SIFS0191 ~ SIFS0520  
1/F ELEVATION B

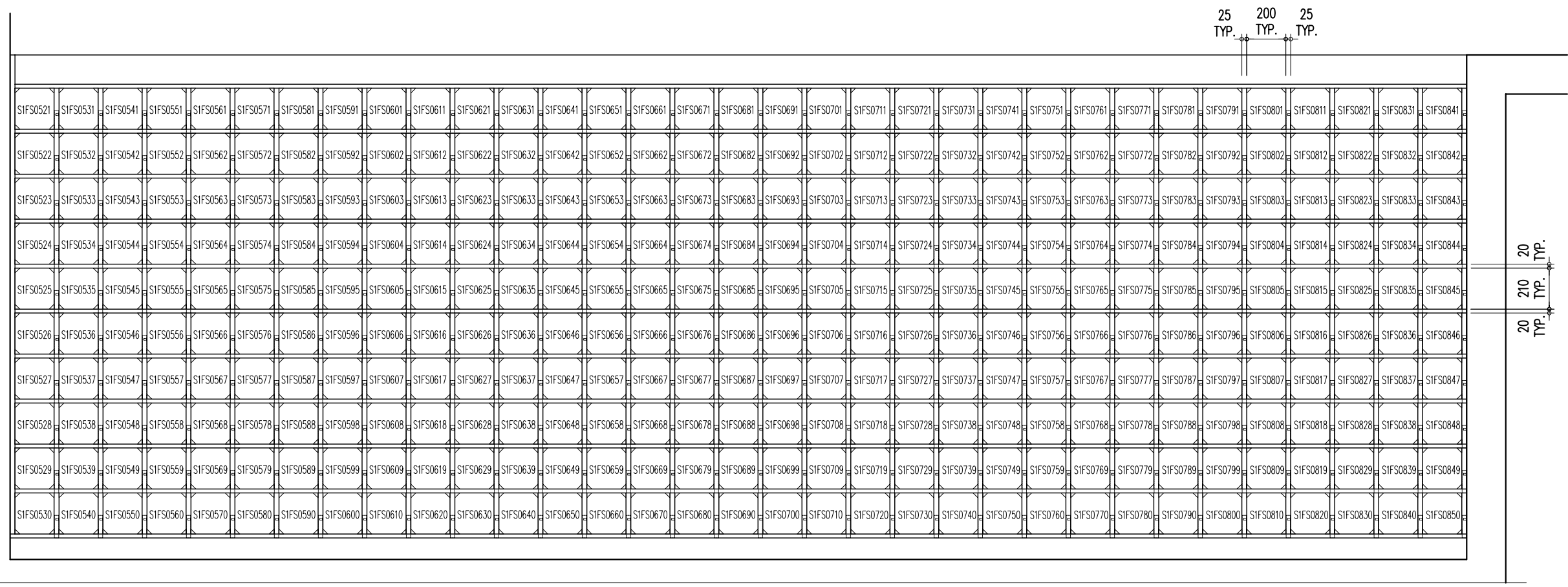

SIFS0521 ~ SIFS0850  
1/F ELEVATION A

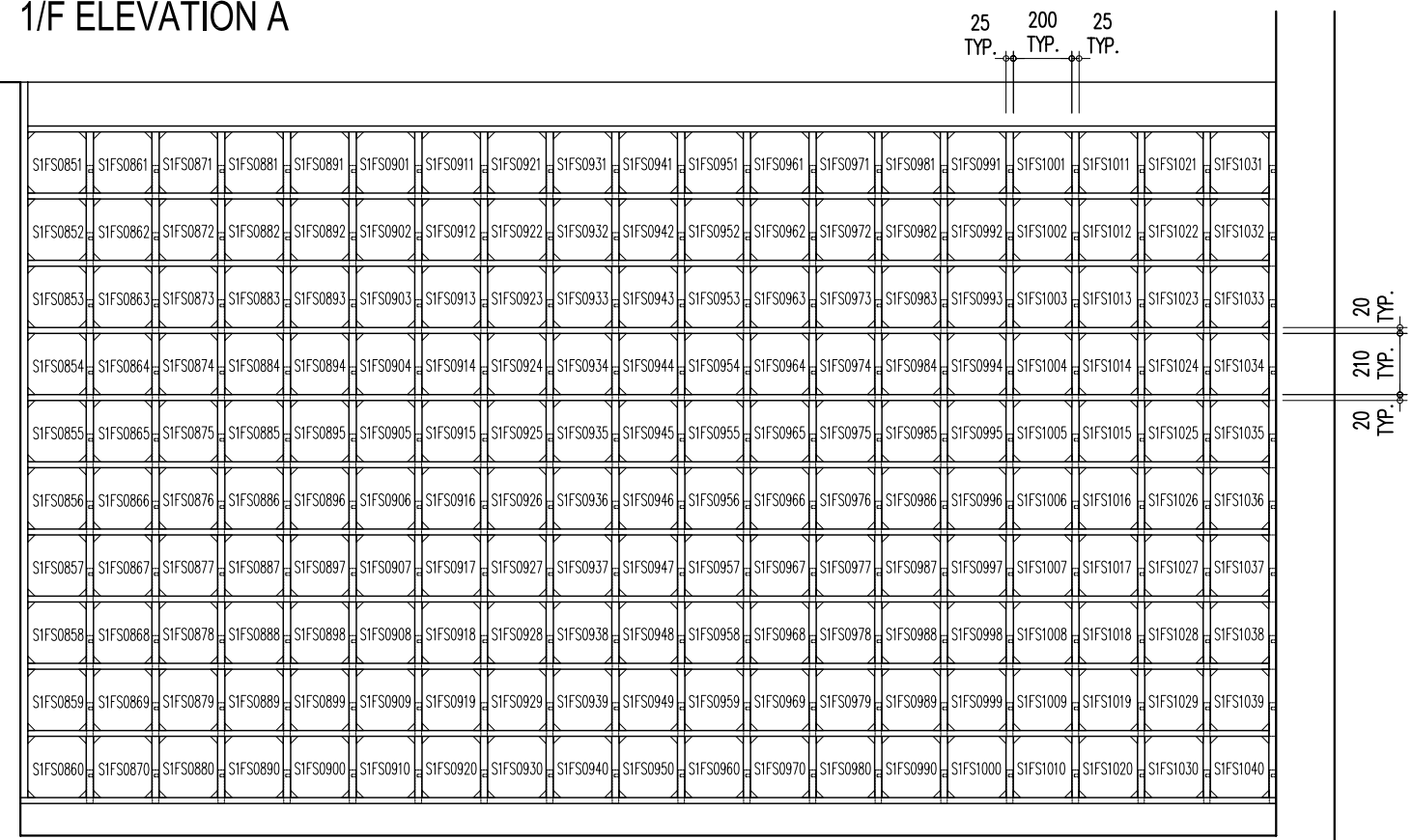

SIFS0851 ~ SIFS1040  
1/F ELEVATION B

FLOOR LEVEL

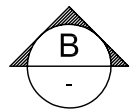
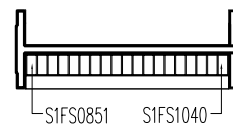
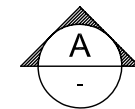
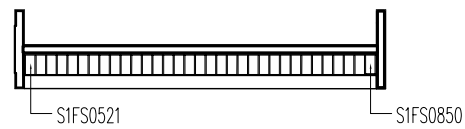

1/F FLOOR PLAN

FLOOR LEVEL